



ATTA DENTAL INSTRUMENTS

Manufacturers & Exporters Medical, Dental & Manicure Instruments.



Dental Instruments Catalogue

Dear Valued Buyers

We feel immense pleasure to present our latest catalogue in which we have featured a most comprehensive range of all types of quality Surgical & Dental instruments required for day to day use for Hospital. We will be pleased to quote you a competitive Price and Delivery time.

All instruments are manufactured according to the recognized standard patterns currently in use in Hospital throughout the world and are being produced under restrict control of experts to avoid any flaw and to refrain any complaint at any stage.

A group of very vast experienced persons in manufacturing handling our quality Control System.

Any instruments proven defective in workmanship or material will be replaced with out charges.

We express our thanks to all our customers for the confidence they have placed us in the past. We further assure them that we will continue our best efforts to gain their confidence in the future.

We are always at your service.

Chief Executive

ATTA DENTAL INSTRUMENTS



01

EXTRACTING FORCEPS

Page # 01 - 28

02

ROOT ELEVATORS

Page # 29 - 48

03

**DIAGNOSTIC, PROBES, SCALERS, FILLING
& LABORATORY INSTRUMENTS**

Page # 49 - 98

04

**MAXILLOFACIAL SURGERY
INSTRUMENTS**

Page # 99 - 124

05

**ORTHODONTIC INSTRUMENTS
& PLIERS**

Page # 125 - 144

06

**DENTAL IMPLANT INSTRUMENTS
& Impression Tray**

Page # 145 - 182

07

HOLLOWARE

Page # 183 - 191

Handle Selection For Extracting Forceps

Dear Valued Buyers if any Universal Fig. No. of Extracting Forceps not Found in our Catalogue you Can Refer the Fig. No. From These Diagram.

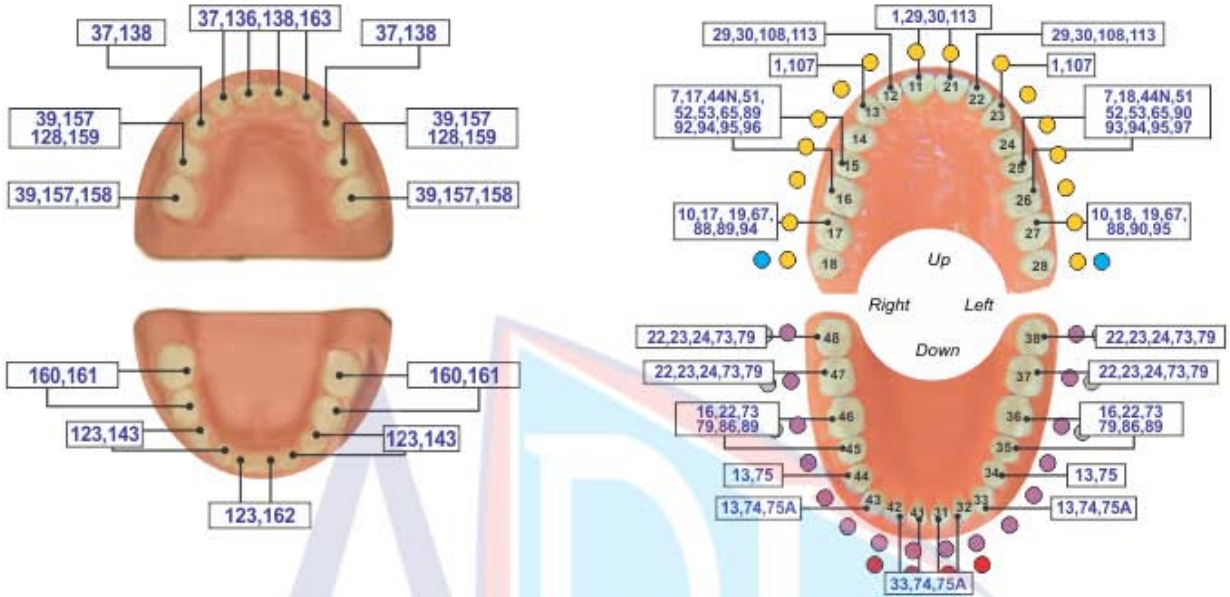

Dear Valued Buyers these are our Handle Styles



EXTRACTING FORCEPS (English Pattern)

- Щипцы экстракционные (английская форма)
- Daviers (Forme Anglaise)
- Zahnzangen (Englische Form)
- Щипці екстракційні (англійська форма)
- Forceps de Extracció (Forme Inglesa)
- استخراج الملقط (نمط اللغة الإنجليزية)

Function: To remove teeth from bony socket



Straight extracting forceps for upper incisors and canines



Straight extracting forceps for upper incisors and canines



Straight extracting forceps for upper incisors and canines

EXTRACTING FORCEPS (English Pattern)



- Щипцы экстракционные (английская форма)
- Щипці екстракційні (англійська форма)
- Daviers (Forme Anglaise)
- Forceps de Extracción (Forme Inglesa)
- Zahnzangen (Englische Form)
- استخراج الملقط (نمط اللغة الإنجليزية)

Function: To remove teeth from bony socket



DE-011
18A
upper molars



DE-012
19
upper third molars



DE-013
20
lower third molar



DE-014
24
lower molar, right



DE-015
29
upper roots



DE-016
30
Upper Roots

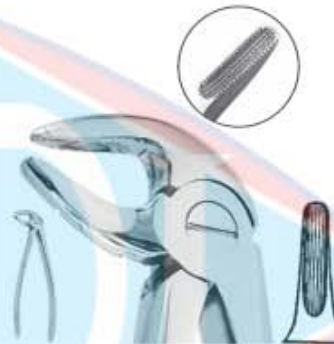

DE-017
33
lower roots



DE-018
33A
Lower Roots



DE-019
33M
Lower roots
with long beak



DE-020
46L



DE-021
51
Upper Roots



DE-022
51A
Upper Roots



Straight extracting forceps for upper incisors and canines



Straight extracting forceps for upper incisors and canines



Straight extracting forceps for upper incisors and canines

EXTRACTING FORCEPS (English Pattern)

- Щипцы экстракционные (английская форма)
- Щипці екстракційні (англійська форма)
- Daviers (Forme Anglaise)
- Forceps de Extracción (Forme Inglesa)
- Zahnzangen (Englische Form)
- استخراج الملقط (نمط اللغة الإنجليزية)

Function: To remove teeth from bony socket

WISDOM EXTRACTING FORCEPS



DE-023
Routerier
(# 22 1/2 L)
lower molars and
wisdoms, left



DE-024
Routerier
(# 22 1/2 R)
lower molars and
wisdoms, right



DE-025
Routerier
(# 33 1/2 L)
lower molar and
wisdom roots, left



*Routerier extracting forceps for lower molars
and third molars, right*



DE-026
Routerier
(# 33 1/2 R)
lower molar and
wisdom roots, right



DE-029
51AL



DE-030
67
Upper Third Molars



DE-031
67A
Upper Third Molars



DE-032
79
Lower Third Molars



Angled extracting forceps for upper roots



DE-027
Fig. 186L
lower molars



DE-028
Fig. 186R
lower molars

EXTRACTING FORCEPS (English Pattern)



- Щипцы экстракционные (английская форма)
- Щипцы екстракційні (англійська форма)
- Daviers (Forme Anglaise)
- Forceps de Extracción (Forme Inglesa)
- Zahnzangen (Englische Form)
- استخراج الملقط (نمط اللغة الإنجليزية)



**DE-033
73**
Lower Molars



**DE-034
73 A**
lower molars



**DE-035
73 S**



**DE-036
74**
Lower Roots



**DE-037
74N**
Lower Roots



**DE-038
75**
Lower Premolars



**DE-039
86A**
Lower Molars



**DE-040
86B**
lower molars



**DE-041
86C**
lower molars



**DE-042
87**
Lower Molars



**DE-043
89**
Upper Molars,
Right



**DE-044
90**
Upper Molars,
Left



Straight extracting forceps for upper incisors and canines



Straight extracting forceps for upper incisors and canines



Straight extracting forceps for upper incisors and canines



EXTRACTING FORCEPS (English Pattern)

- Щипцы экстракционные (английская форма)
- Daviers (Forme Anglaise)
- Zahnzangen (Englische Form)
- Щипці екстракційні (англійська форма)
- Forceps de Extracción (Forme Inglesa)
- استخراج الملقط (نمط اللغة الإنجليزية)

A-TRAUMATIC EXTRACTION

Improved tapered beaks for complete root contact. Cross serrations. Deep Gripe Extracting Forceps



- No Fracture
- No Tissue Damage
- Extraction With Easy



Thin Tip

**DE-045
34**
Upper incisors and
premolars
deep-gripping



Wide Tip

**DE-046
34A**
Upper centrals / cains
deep-gripping



Thin Tip

**DE-047
Fig. 35**
upper permolars
deep-gripping



Wide Tip

**DE-048
35A**
Upper incisors and
premolars
deep-gripping



Thin Tip

**DE-049
36**
Lower premolars
deep-gripping



Wide Tip

**DE-050
36A**
Lower premolars
deep-gripping



**DE-051
336**
lower permolars
deep-gripping



**DE-052
F-7C**
lower molar



**DE-053
9**
Apex Forceps Lower Universal
Deep Root Pick



**DE-054
79N**
Lower third molars
deep-gripping



**DE-055
79**
Lower Thrid Molars



Function:

Extraction forceps are used to further loosen teeth by rotational and tilting movements and finally to extract the teeth in combination with a fulcrum.

EXTRACTING FORCEPS (English Pattern)



- Щипцы экстракционные (английская форма)
- Daviers (Forme Anglaise)
- Zahnzangen (Englische Form)
- Щипці екстракційні (англійська форма)
- Forceps de Extracción (Forme Inglesa)
- استخراج الملقط (نمط اللغة الإنجليزية)

DEEP ROOT PICK FORCEPS



DE-056
146
Apex Forceps Lower Root
Deep Root Pick



DE-057
153
Apex Forceps Upper Root
Deep Root Pick



DE-058
149
Apex Forceps Upper Root
Deep Root Pick



DE-061
Fig. 44



DE-060
Fig. 44Z



DE-059
Fig. 45Z



DE-062
46XL
Apex Forceps Lower Root
Deep Root Pick



DE-063
67
Upper Third Molars



DE-064
67A
Upper Third Molars



DE-065
67N
Lower third molars
deep-gripping



DE-066
331
upper roots
deep-gripping



forceps for upper incisors, premolars and roots





EXTRACTING FORCEPS (English Pattern)

- Щипцы экстракционные (английская форма)
- Daviers (Forme Anglaise)
- Zahnzangen (Englische Form)
- Щипці екстракційні (англійська форма)
- Forceps de Extracció (Forme Inglesa)
- استخراج الملقط (نمط اللغة الإنجليزية)



Fig. 1
upper
laterals
and canines



DE-067
Set of 10 Pieces
Fig. 1
Fig. 7
Fig. 13
Fig. 17
Fig. 18
Fig. 22
Fig. 51A
Fig. 67
Fig. 74N
Fig. 79

Fig. 7
upper premolars



Fig. 13
lower premolars



Fig. 17
upper molars, right



Fig. 18
upper molars, left



Fig. 22
lower roots



Fig. 51A
upper roots



Fig. 67
upper third molars



Fig. 74N
lower molar



Fig. 79
lower third molars



Extracting forceps for upper roots



EXTRACTING FORCEPS



- Щипцы экстракционные
 - Daviers
 - Zahnzangen
- Щипці екстракційні
 - Forceps de Extracción
 - استخراج الملقط

Pediatric Tooth Extracting Forceps Set



DE-069
English Pattern Klein #51S
Pedodontic Upper root



DE-068
English Pattern Klein #137
Pedodontic, Upper Incisors Spring handle



DE-072
English Pattern Klein #5
Pedodontic Lower Incisors.



DE-070
English Pattern Klein #139
Pedodontic Upper Premolars

Baby Tooth Extraction Forceps



DE-075
Fig. # 01 to 07
Set of 7 Pieces



DE-073
English Pattern Klein #7
Pedodontic Lower Roots,



DE-071
English Pattern Klein #3
Pedodontic Upper Molars Universal

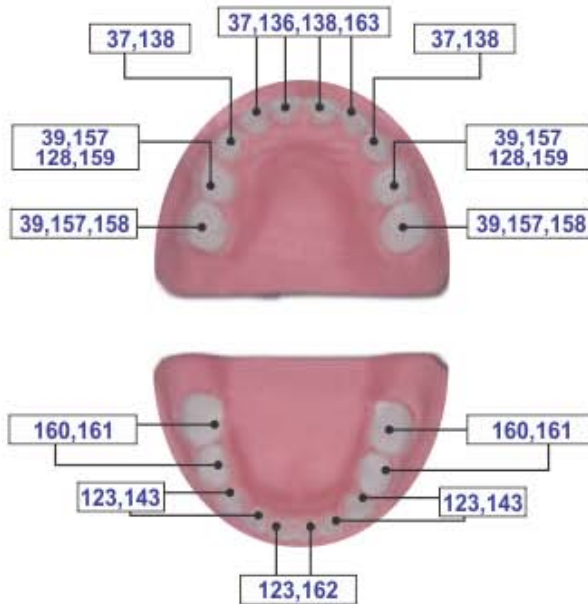

DE-074
English Pattern Klein #6
Pedodontic Lower Molars, Spring Handle



ROOT FRAGMENT FORCEPS



Witzel
DE-076
170mm
Upper roots, Universal



Witzel
DE-077
165mm
Lower roots, Universal



DE-078
#400(300)
165mm
Upper roots, Universal



DE-079
#401(301)
160mm
Lower roots, Universal



DE-080
Witzel Forceps With Gold
Set of 3 Pcs



DE-084
Witzel Forceps With Hole And Screw Pattern
Set of 3 Pcs



DE-088
Witzel Forceps With Anatomical Handle
Set of 3 Pcs



DE-081
#401(301)
160mm
Lower roots, Universal



DE-085
#401(301)
160mm
Lower roots, Universal



DE-089
#401(301)
160mm
Lower roots, Universal



DE-082
#400(300)
165mm
Upper roots, Universal



DE-086
#400(300)
165mm
Upper roots, Universal



DE-090
#400(300)
165mm
Upper roots, Universal



Witzel
DE-083
165mm
Lower roots, Universal



Witzel
DE-087
165mm
Lower roots, Universal



Witzel
DE-091
165mm
Lower roots, Universal

ROOTS SPLINTER FORCEPS



- Щипцы для удаления корневых осколков
- Pincas Fragments
- Wurzelsplitterzangen
- Щипці для видалення корневих осколків
- Pinzas Para Fragmentos
- جوار منشقة المنقط



DE-092
Splinter Forceps
15.5cm



Stieglitz Root Splinter Forceps



DE-093
Splinter Forceps
15.5cm 45°

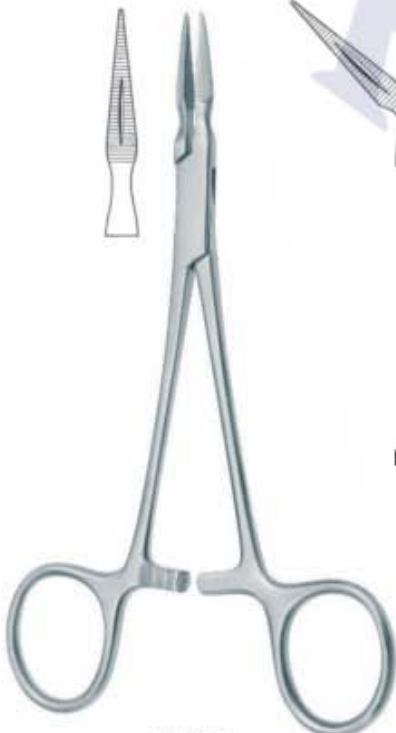

DE-094
Stieglitz
Root Fragments



DE-095
Stieglitz
Root Fragments



DE-096
Stieglitz Splinter Forceps
140mm 90°



DE-097
Stieglitz Splinter Forceps
140mm Straight

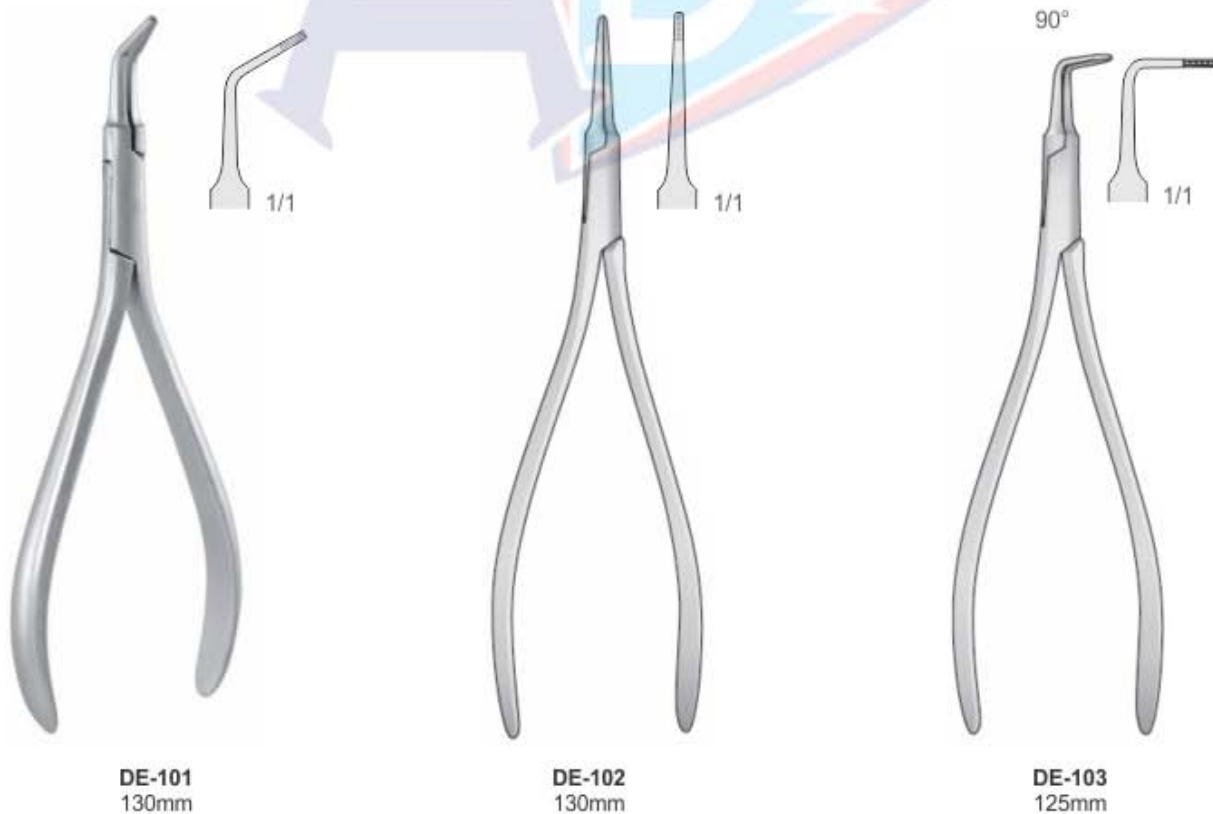
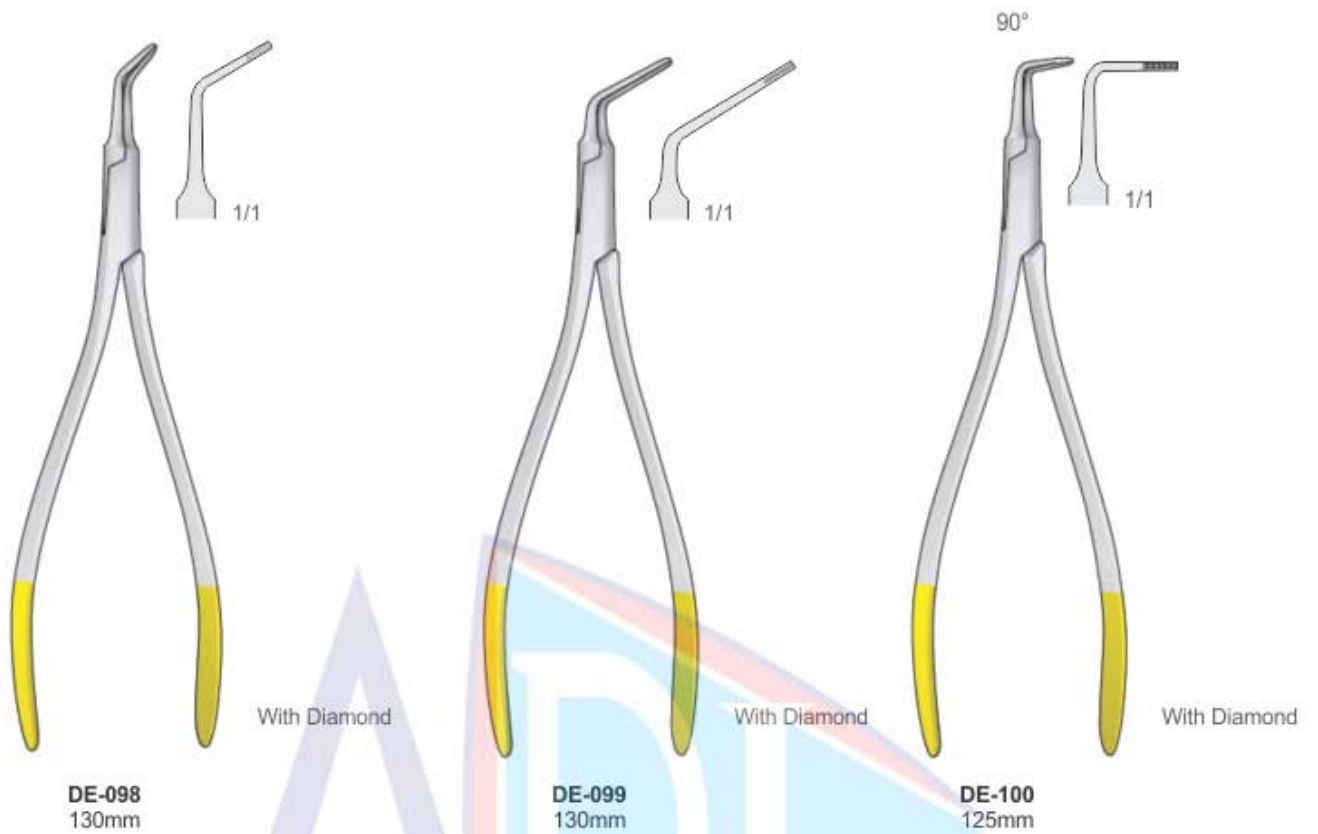

EXTRACTING FORCEPS (American Pattern)



- Щипцы экстракционные (американская форма)
- Щипці екстракційні (американська форма)
- Daviers - forme américaine
- Pinzere per estrazione - forma americana
- Fórceps de extracción - forma americana
- استخراج المنطق (النمط الأمريكي)



DE-104
1STD
Winter
upper centrals and canines

DE-105
Fig. 1
upper incisors
and roots

DE-106
Cryer
Fig. 150



EXTRACTING FORCEPS (American Pattern)

- Щипцы экстракционные (американская форма)
- Щипці екстракційні (американська форма)
- Daviers - forme américaine
- Pinzere per estrazione - forma americana
- Fórceps de extracción - forma americana
- استخراج المنقط (النمط الأمريكي)



DE-107
Fig. 150A
Cryer
upper incisors, premolars, roots



DE-108
Fig. 62
incisors, premolars,
deciduous teeth



DE-109
10S
upper roots



DE-110
17
lower molars



DE-111
Harris
Fig. 18R



DE-112
Harris
Fig. 18L



EXTRACTING FORCEPS (American Pattern)



- Щипцы экстракционные (американская форма)
- Daviers - forme américaine
- Fórceps de extracción - forma americana
- Щипці екстракційні (американська форма)
- Pinzere per estrazione - forma americana
- استخراج الملقط (النمط الأمريكي)

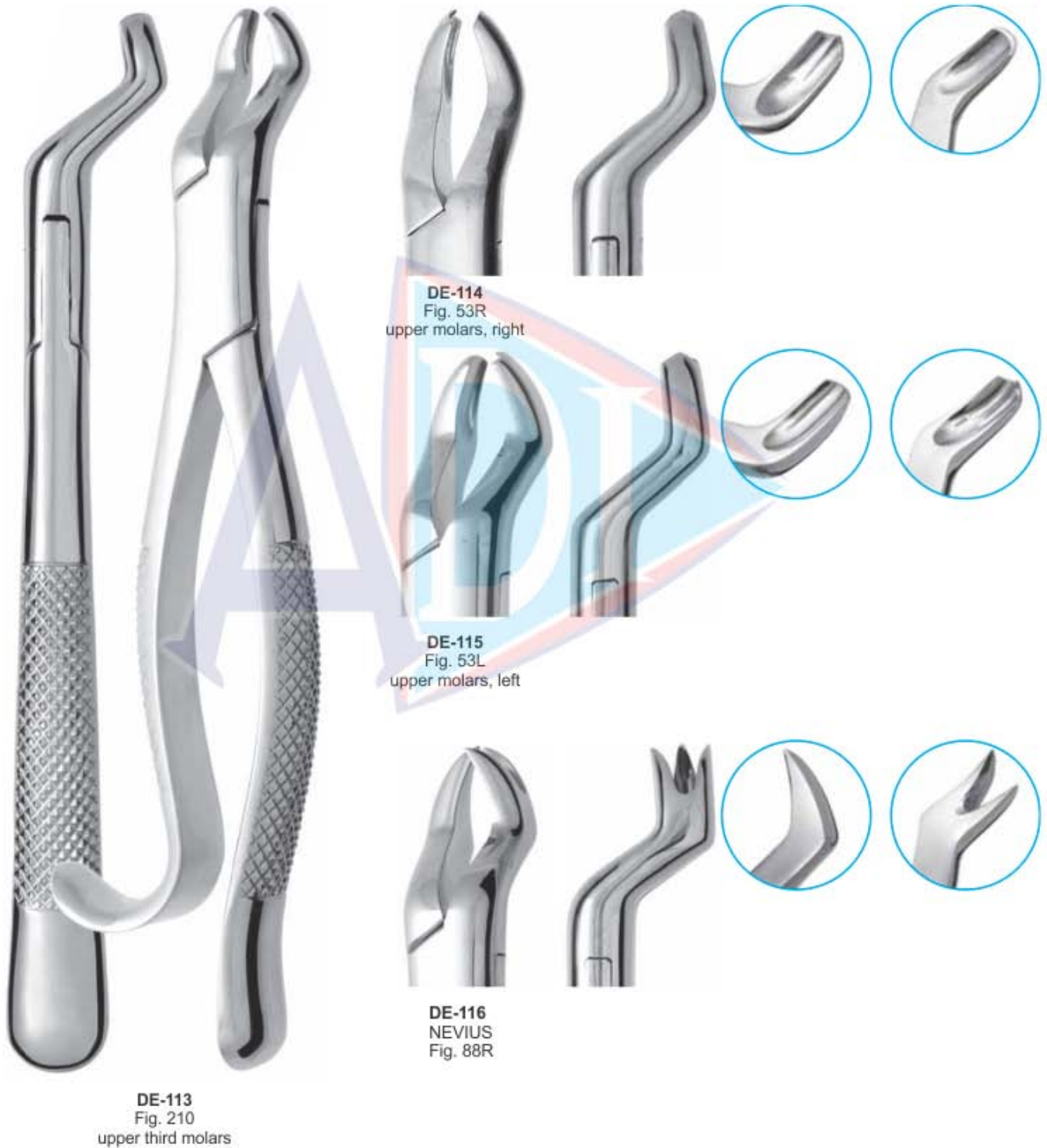

EXTRACTING FORCEPS (American Pattern)

- Щипцы экстракционные (американская форма)
- Daviers - forme américaine
- Fórceps de extracción - forma americana
- Щипці екстракційні (американська форма)
- Pinzere per estrazione - forma americana
- استخراج المنقط (النمط الأمريكي)



DE-117
Fig. 24
upper molars



DE-118
210S
upper third molars



DE-119
210H
upper third molars



DE-120
286
Upper Roots,
Premolars, Incisors



DE-121
99C
Kells
upper incisors,
canines, premolars



DE-122
222
lower third molars



DE-123
286
Lower Molar

EXTRACTING FORCEPS (American Pattern)



- Щипцы экстракционные (американская форма)
- Daviers - forme américaine
- Fórceps de extracción - forma americana
- Щипці екстракційні (американська форма)
- Pinzeta per estrazione - forma americana
- استخراج الملقط (النمط الأمريكي)



DE-124
Nevius
Fig. 88L
upper molars, left

DE-125
Fig. 65
upper incisors
and roots

DE-126
Parmly Fig. 32A
upper premolars
and roots

DE-127
Parmly Fig. 32
upper premolars
and molars

EXTRACTING FORCEPS (American Pattern)

- Щипцы экстракционные (американская форма)
- Щипці екстракційні (американська форма)
- Daviers - forme américaine
- Pinzere per estrazione - forma americana
- Fórceps de extracción - forma americana
- استخراج المنطق (النمط الأمريكي)



DE-128
COHEN
universal

DE-129
Fig. 203
lower incisors
and roots

DE-130
Tomes Fig. 69
upper and lower
roots

EXTRACTING FORCEPS (American Pattern)



- Щипцы экстракционные (американская форма)
- Щипці екстракційні (американська форма)
- Daviers - forme américaine
- Pinzereper per estrazione - forma americana
- Fórceps de extracción - forma americana
- استخراج المنطق (النمط الأمريكي)



DE-131
Fig. 23
lower molars

DE-132
Fig. 16
lower molars

DE-133
Physic Fig. 5
lower third molars

DE-134
Harris Fig. 15
lower molars

DE-135
Fig. 103

EXTRACTING FORCEPS (American Pattern)

- Щипцы экстракционные (американская форма)
- Щипці екстракційні (американська форма)
- Daviers - forme américaine
- Pinzere per estrazione - forma americana
- Fórceps de extracción - forma americana
- استخراج المنقط (النمط الأمريكي)



DE-136
Hull
Fig. 101
Deciduous teeth

DE-137
Cryer
Fig. 150S
upper teeth,
for children

DE-138
Fig. 150 AS

EXTRACTING FORCEPS (American Pattern)



- Щипцы экстракционные (американская форма)
- Daviers - forme américaine
- Fórceps de extracción - forma americana
- Щипці екстракційні (американська форма)
- Pinzere per estrazione - forma americana
- استخراج الملقط (النمط الأمريكي)



DE-139
Cryer
Fig. 151
lower teeth,
for children

DE-140
Fig. 151 S
lower incisors,
premolars, roots

DE-141
Fig. 151 AS



EXTRACTING FORCEPS (American Pattern)

- Щипцы экстракционные (американская форма)
- Daviers - forme américaine
- Fórceps de extracción - forma americana
- Щипці екстракційні (американська форма)
- Pinzere per estrazione - forma americana
- استخراج المنقط (النمط الأمريكي)



DE-142
16S
lower molars for children



DE-143
17S
lower molars



DE-144
23 S
Lower molars

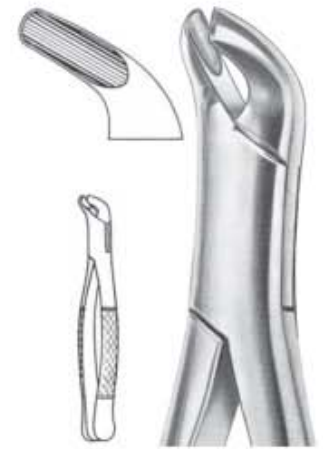

DE-145
27
lower molars



DE-146
18LS
upper molars left



DE-147
18RS
upper molars right



DE-148
85 Tomas
lower canines, premolars and molars



DE-149
85A Tomas
lower canines, premolars and molars



DE-150
69S
upper and lower roots



DE-151
99A Kells
upper incisors, canines, premolars



DE-152
217
lower molars

EXTRACTING FORCEPS (American Pattern)



- Щипцы экстракционные (американская форма)
- Щипці екстракційні (американська форма)
- Daviers - forme américaine
- Pinzere per estrazione - forma americana
- Fórceps de extracción - forma americana
- استخراج الملقط (النمط الأمريكي)



DE-153
#10 SK
Upper Molars Sup



DE-154
#17 SK Universal
Lower Molars



DE-155
#23 SK Universal
Upper Molars



DE-156
#69 SK Tomas
upper and lower roots



DE-157
#99 SK
upper incisors,
canines, premolars



DE-158
#150 SK
upper incisors,
premolars, roots



DE-159
#151 SK
lower incisors,
premolars, roots



DE-160
#222 SK
lower third molars

EXTRACTING FORCEPS (American Pattern)

- Щипцы экстракционные (американская форма)
- Щипці екстракційні (американська форма)
- Daviers - forme américaine
- Pinzere per estrazione - forma americana
- Fórceps de extracción - forma americana
- استخراج المنطق (النمط الأمريكي)



DE-161
Fig. 1
Upper Anterior

DE-162
Lower Molar
Fig. 23 Cow Horn



DE-163
Fig. 74
Lower Anterior



DE-164
Fig. 88L
Upper Molar Left



DE-165
Fig. 88R
Upper Molar Right



DE-166
Fig. 74
Lower Anterior



DE-167
Fig. 106
Lower Incisors



DE-168
Fig. 174
Extra Narrow
Lower Anterior
Apical Retention
Forceps



DE-169
Fig. 859
Lower Molars
Roots



EXTRACTING FORCEPS (American Pattern)



- Щипцы экстракционные (американская форма)
- Щипці скстракційні (американська форма)
- Daviers - forme américaine
- Pinzere per estrazione - forma americana
- Fórceps de extracción - forma americana
- استخراج الملقط (النمط الأمريكي)

Carbide Diamond Coated Point



DE-170
150 T.C.
Carbide Serrated Beak
Upper Incisors, Cuspids,
Bicuspid & Roots,
Universal



DE-171
151 T.C.
Carbide Serrated Beak
Lower Incisors, Cuspids,
Bicuspid & Roots, Universal



DE-172
15TD T.C.
Carbide Serrated Beak
Upper Incisors, Cuspids,



DE-173
17 T.C.
Carbide Serrated Beak
1st & 2nd Lower Molars,
Universal



DE-174
53L T.C.
Carbide Serrated Beak
1st & 2nd Upper Molars,
Left



DE-175
53R T.C.
Carbide Serrated Beak
1st & 2nd Upper Molars,
Right



DE-176
65 T.C.
Carbide Serrated Beak
Upper Incisors, Roots &
Fragments



DE-177
69 T.C.
Carbide Serrated Beak
Upper & Lower Fragments
And Roots



DE-178
150S T.C. Pedro forcep
Carbide Serrated Beak
Pedo, Upper Primary Teeth
and Roots, Universal



DE-179
151S T.C. Pedro forcep
Carbide Serrated Beak
Pedo, Lower Primary Teeth
and Roots, Universal

BONE ROUNGER

- Костные кусачки
- Hohlmeißelzangen
- Pincés-gouges
- Кусачки для кісток
- Pinzas-gubias
- روتجورس العظام



DE-180
Blumenthal
15cm



DE-181
Blumenthal
15cm



DE-182
Blumenthal
15cm



DE-183
Friedman
14cm



DE-184
Friedman
14.5cm



DE-185
Micro-Friedman
14cm



DE-186
Micro-Friedman
15cm



DE-187
Micro-Friedman
16cm



DE-188
Kleinert-Kutz
18.5cm



DE-189
Beyer
18.5cm



DE-190
Mead 1A
18.5cm



DE-191
Luer
18.5cm

EXTRACTING FORCEPS (English Pattern)



- Щипцы экстракционные (английская форма)
- Щипці екстракційні (англійська форма)
- Forceps de Extracción (Forme Inglesa)
- استخراج الملقط (نمط اللغة الإنجليزية)
- Daviers (Forme Anglaise)
- Zahnzangen (Englische Form)

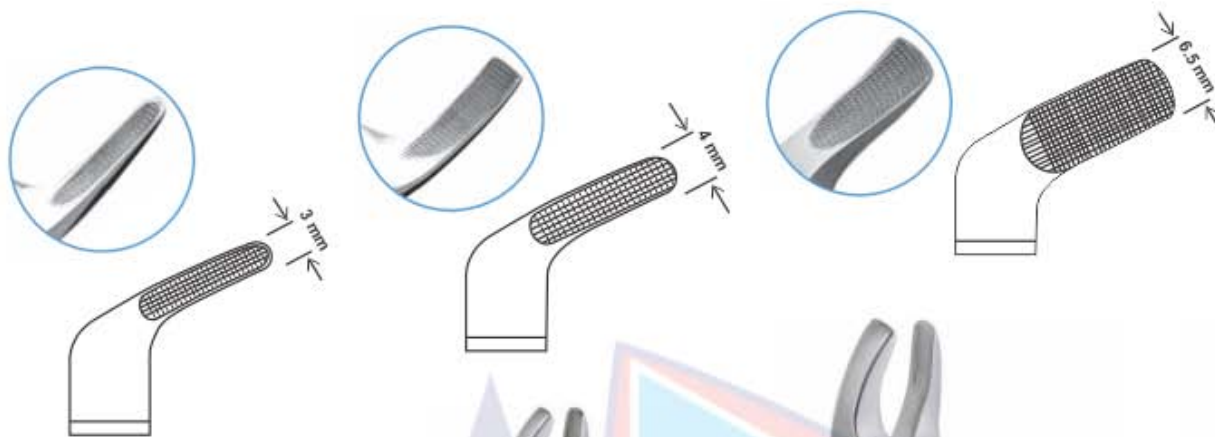

DE-192
Meissner
Extracting Forceps



DE-193
Meissner
Extracting Forceps



DE-194
Meissner
Extracting Forceps



DE-195
Comellas Forceps
Anatomical Handle



DENTAL SYRINGES

- Шприцы стоматологические карпульные
- Шприці стоматологічні карпульні
- Seringues à usage dentaire
- Jeringas dentales
- Dentalspritzen
- المحاقن الأسنان



DE-196 1.8ml
DE-197 2.2ml



DE-198 1.8ml
DE-199 2.2ml



DE-200 1.8ml
DE-201 2.2ml



DE-202 1.8ml
DE-203 2.2ml



DE-204 1.8ml
DE-205 2.2ml



DE-206 1.8ml
DE-207 2.2ml



DE-208
1001
Intriligamental
Anesthesia
Syringe in
Black Colour



DE-209 1.8ml
DE-210 2.2ml
Angled



DE-211
Aluminium - Dark 1.8 ml

- DE-212 Aluminium - Silver 1.8 ml
- DE-213 Aluminium - Orange 1.8 ml
- DE-214 Aluminium - Green 1.8 ml
- DE-215 Aluminium - Blue 1.8 ml



Type C
DE-216 1,8ml
DE-217 2,2ml



Type C
DE-218 1,8ml
DE-219 2,2ml



2-Ring
DE-220 1,8ml
DE-221 2,2ml



Aspirating Syringe
DE-222 1,8mm
DE-223 2,2mm

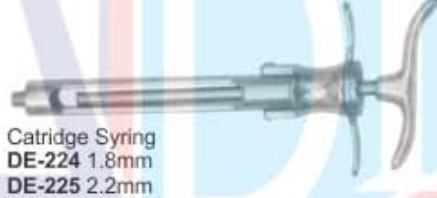

Cartridge Syringe
DE-224 1,8mm
DE-225 2,2mm



Cartridge Syringe
DE-226 1,8mm
DE-227 2,2mm



Cartridge Syringe
DE-228 1,8mm
DE-229 2,2mm

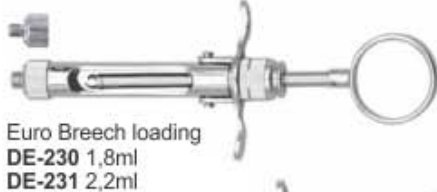

Euro Breech loading
DE-230 1,8ml
DE-231 2,2ml



EuroBreech loading
DE-232 1,8ml
DE-233 2,2ml



Manual Aspirating Syringe
DE-234 1,8ml
DE-235 2,2ml



Quatro
DE-236 1,8ml
DE-237 2,2ml



Trio
DE-238 1,8ml
DE-239 2,2ml



Swedish Type
DE-240 1,8ml
DE-241 2,2ml



Ject Ultima
DE-242 1,8ml
DE-243 2,2ml
Injects 0,05 ml with every click Supplied with angled and straight tubes



Ject angled
DE-244 1,8ml
DE-245 2,2ml



Ject straight
DE-246 1,8ml
DE-247 2,2ml



Disc System
DE-248 1,8ml
DE-249 2,2ml



Disc System
DE-250 1,8ml

EXTRACTING FORCEPS SET



Извлечение щипцов
Ensemble de pinces d'extraction
• Zange sammeln

• Витягуючий комплект щипців
• Extracción del conjunto de fórceps
• استخراج ملقط مجموعة



DE-251
Extracting Forceps
Set of 10 Pieces
Extracting Forceps Fig. 2
Extracting Forceps Fig. 7
Extracting Forceps Fig. 13
Extracting Forceps Fig. 17
Extracting Forceps Fig. 18
Extracting Forceps Fig. 22
Extracting Forceps Fig. 33
Extracting Forceps Fig. 51A
Extracting Forceps Fig. 67A
Extracting Forceps Fig. 79

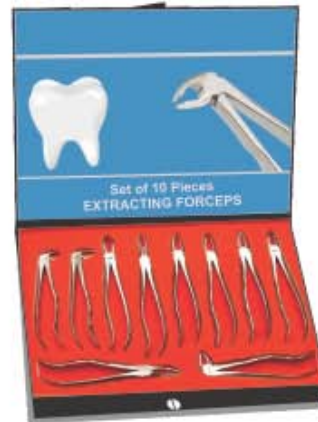

DE-252
Extracting Forceps
Set of 10 Pieces
Extracting Forceps Fig. 2
Extracting Forceps Fig. 7
Extracting Forceps Fig. 13
Extracting Forceps Fig. 17
Extracting Forceps Fig. 18
Extracting Forceps Fig. 22
Extracting Forceps Fig. 33
Extracting Forceps Fig. 51A
Extracting Forceps Fig. 67A
Extracting Forceps Fig. 79



DE-253
Extracting Forceps
Set of 13 Pieces
Extracting Forceps Fig. 2
Extracting Forceps Fig. 7
Extracting Forceps Fig. 13
Extracting Forceps Fig. 17
Extracting Forceps Fig. 18
Extracting Forceps Fig. 22
Extracting Forceps Fig. 33
Extracting Forceps Fig. 51A
Extracting Forceps Fig. 67A
Extracting Forceps Fig. 79
Extracting Forceps Fig. 86C
Extracting Forceps Fig. 89
Extracting Forceps Fig. 90



DE-254
Extracting Forceps Children Pattern
Set of 10 Pieces
Extracting Forceps Fig. 13S
Extracting Forceps Fig. 22S
Extracting Forceps Fig. 30S
Extracting Forceps Fig. 33S
Extracting Forceps Fig. 37
Extracting Forceps Fig. 38
Extracting Forceps Fig. 39
Extracting Forceps Fig. 39L
Extracting Forceps Fig. 39R
Extracting Forceps Fig. 51S



DE-255
Extracting Forceps English adult Adult
Set of 10 Pcs



DE-256
Extracting Forceps American Adult
Set of 10 Pcs



DE-257
Extracting Forceps American Adult
Set of 8 Pcs



DE-258
Extracting Forceps Pedro
Set of 7 Pcs



ROOT ELEVATOR

FUNCTION OF ROOT ELEVATORS IN SURGERY

To Loosen Tooth or Root From Bony Socket Prior to Placement of The Extraction Forceps.

HANDLES FOR ROOT ELEVATORS POINTS A, B, C, D, E, F, G, H



ROOT ELEVATOR

- Элеватор корневой экстракционный
- Elévateurs à racines
- Wurzelheber
- Elevator corneviu extracționiu
- Elevadores para raices
- المصاعد الجذر

Function of Root Elevators:

To loosen tooth or root from bony socket prior to placement of the extraction forceps.

Apexo Root Elevators



Luxator Root Elevators



Bein Root Elevators

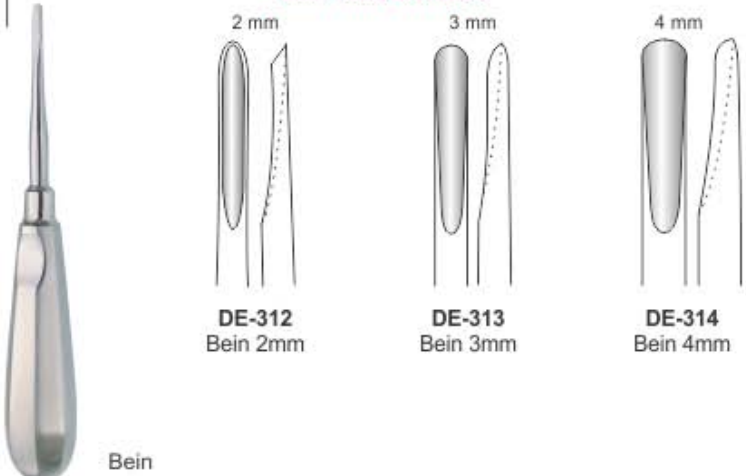

Seldin Root Elevators

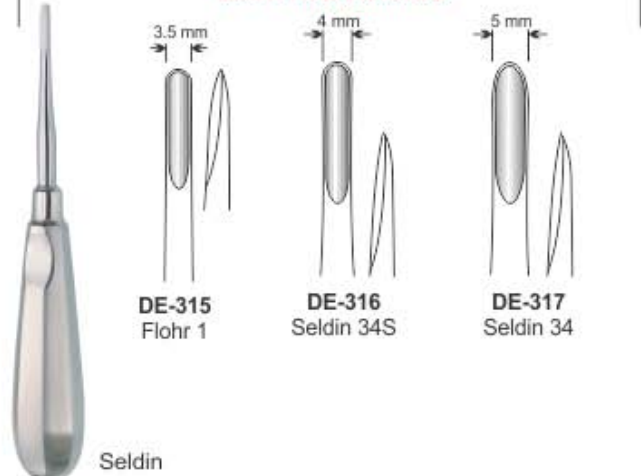

ROOT ELEVATOR

- Элеватор корневой экстракционный
- Elévateurs à racines
- Wurzelheber
- Слеватор корневий екстракційний
- Elevadores para raices
- المصاعد الجذر

FUNCTION: To loosen tooth or root from bony socket prior to placement of the extraction forceps.

Laxutor Root Elevators

Long Type



Laxutor Root Elevator



DE-318
Laxutor
1.5mm
Str.



DE-319
Laxutor
2mm
Str.



DE-320
Laxutor
3mm
Str.



DE-321
Laxutor
5mm
Str.



DE-322
Laxutor
3mm
Cvd.



DE-323
Laxutor
5mm
Cvd.



DE-324
Laxutor
3mm
Upper Angle



DE-325
Laxutor
3mm
Double Angle



DE-326
Laxutor
3mm
Str.



DE-327
Laxutor
5mm
Str.



ROOT ELEVATOR



- Элеватор корневой экстракционный
- Elévateurs à racines
- Wurzelheber
- Слеватор корневий экстракційний
- Elevadores para raices
- المعاعد الجذر

Laxutor Root Elevators

Luxator Roots Elevator



lower roots elevator



Upper root elevator with helicoidal tip



DE-337
Luxator
Straight

DE-338
Luxator
Curved

Function of Root Elevators:

To loosen tooth or root from bony socket prior to placement of the extraction forceps.

Apical Root Elevators

Apical Root Elevators

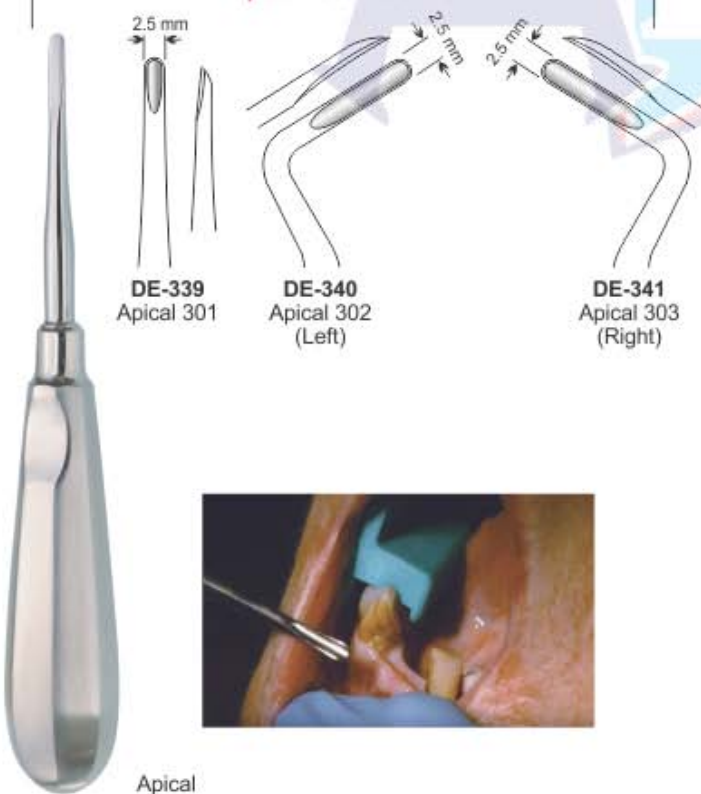

Apical

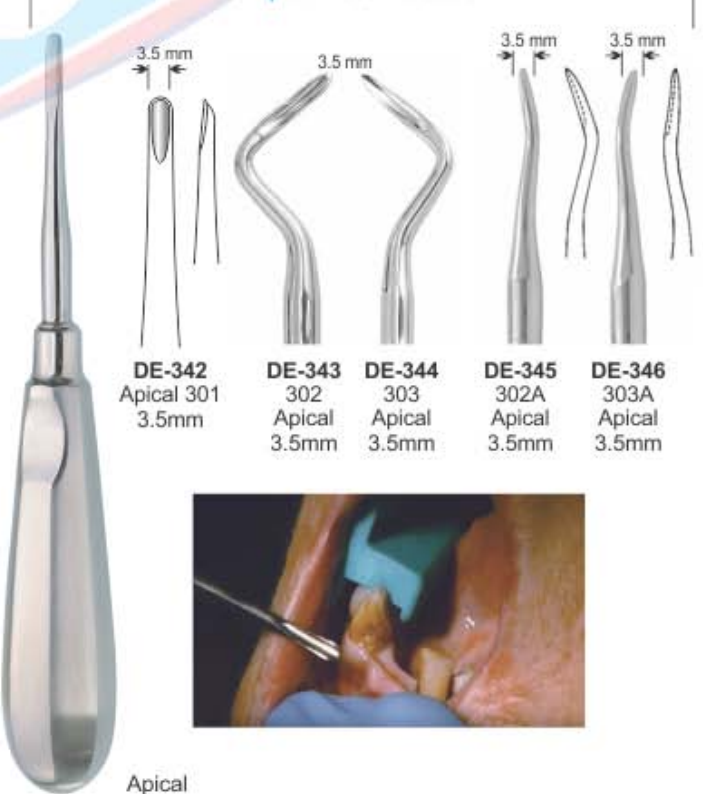

Apical

ROOT ELEVATOR

- Элеватор корневой экстракционный
 - Elévateurs à racines
 - Wurzelheber
- Слеватор корневий экстракційний
 - Elevadores para raices
 - المصاعد الجذر

FUNCTION: To Loosen Tooth or Root From Bony Socket Prior to Placement of The Extraction Forceps.

Cryer Root Elevators

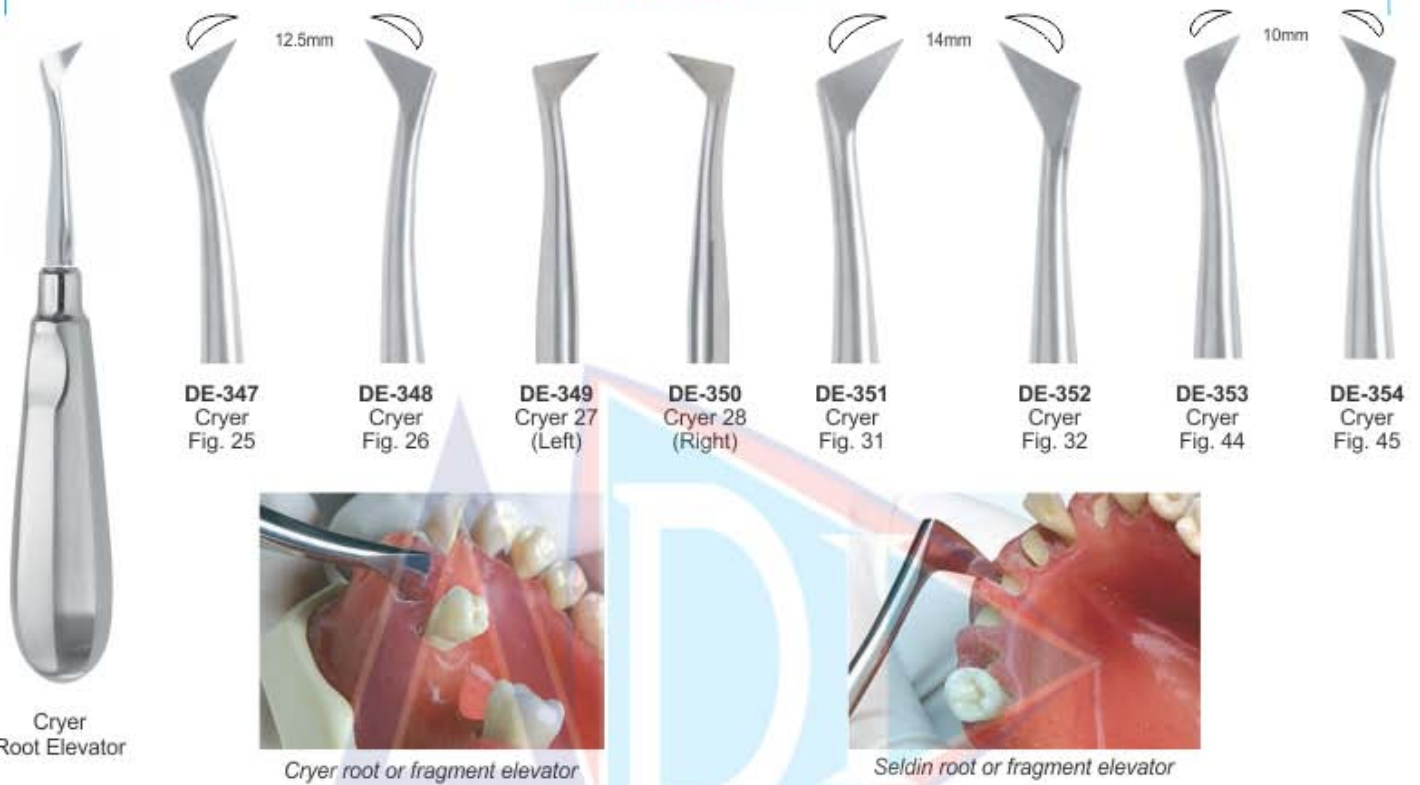

Seldin Root Elevators

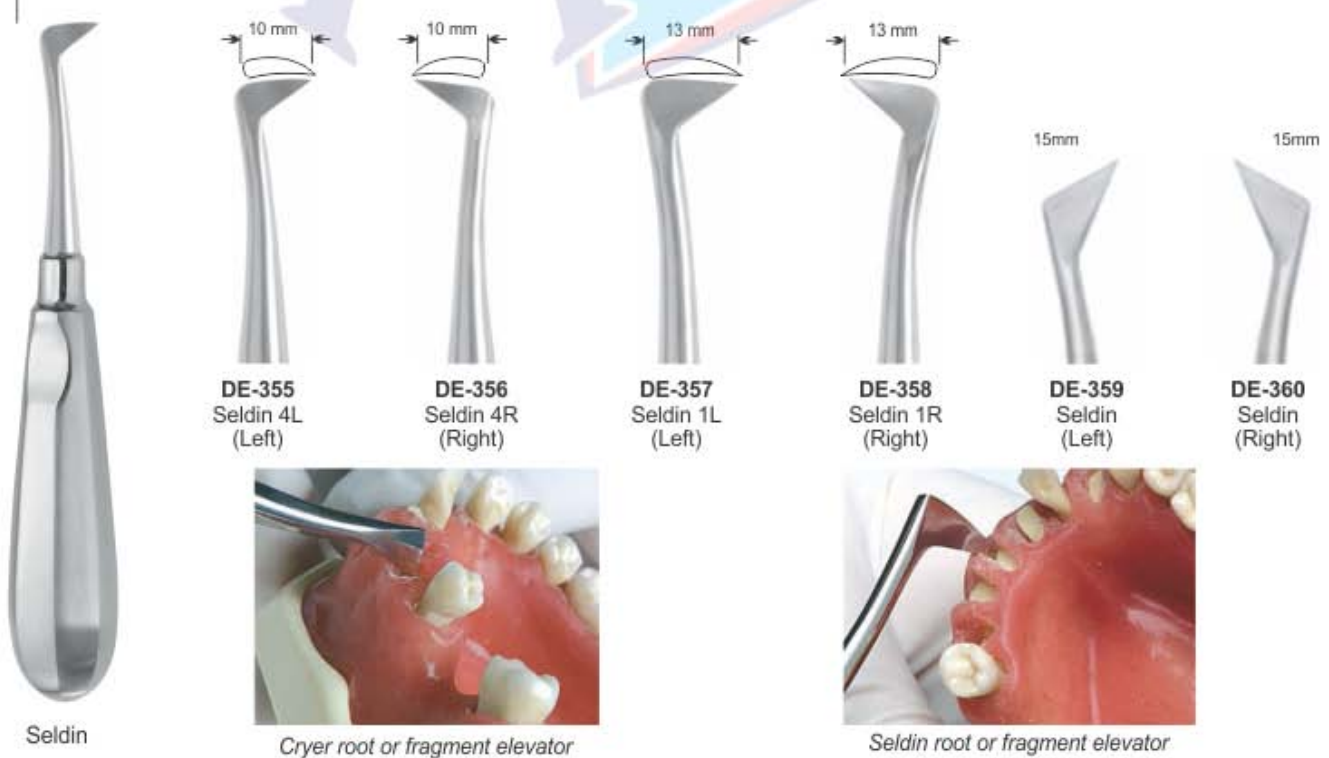

ROOT ELEVATOR



- Элеватор корневой экстракционный
- Elévateurs à racines
- Wurzelheber
- Слеватор корневий экстракційний
- Elevadores para raices
- المصاعد الجذر

FUNCTION: To Loosen Tooth or Root From Bony Socket Prior to Placement of The Extraction Forceps.

Apical Root Elevators

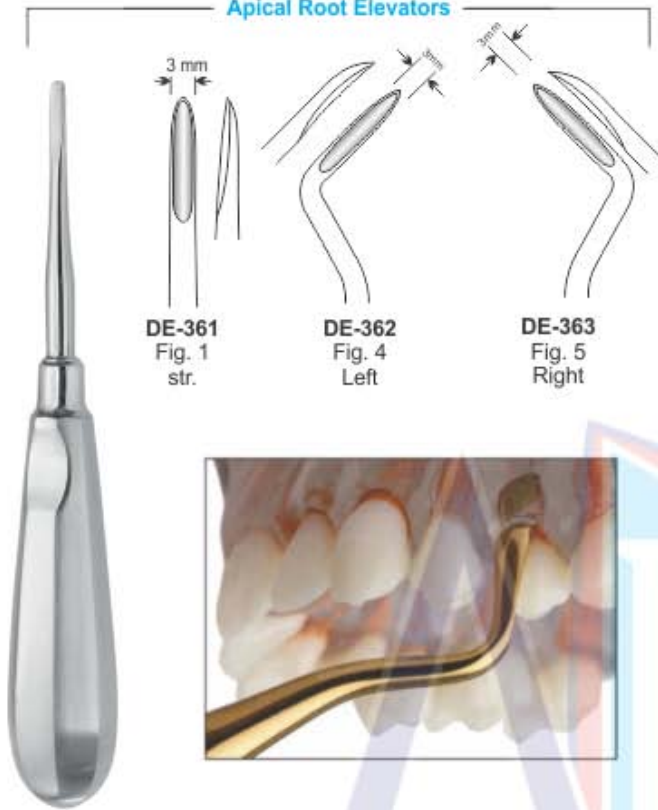

Apical Root Elevators

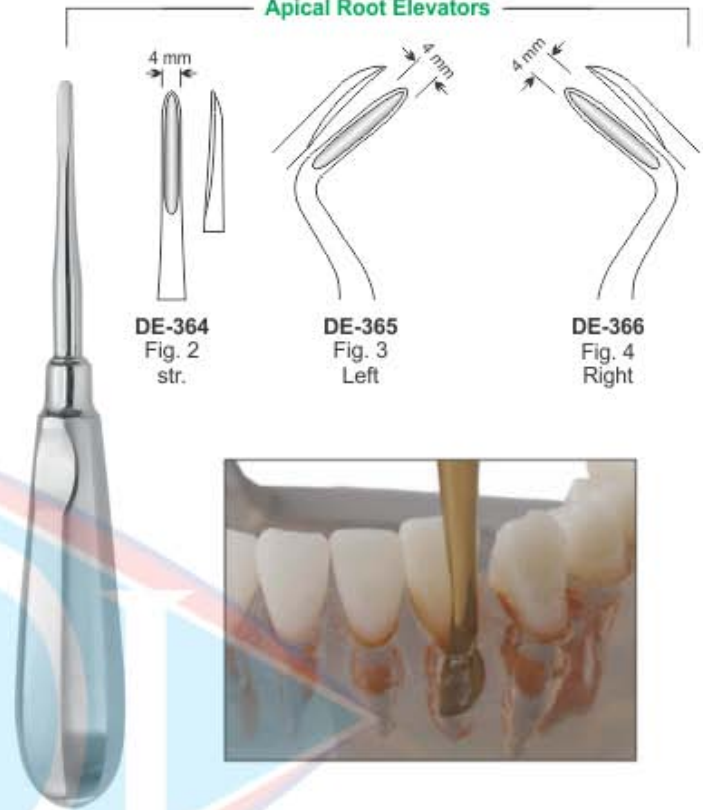

Flohr Root Elevators



Heidbrink Root Elevators

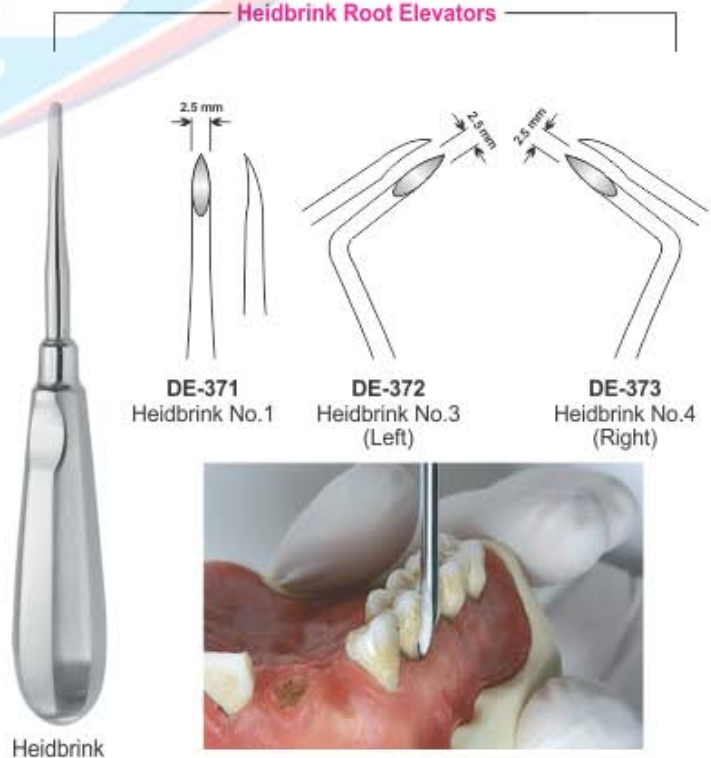

ROOT ELEVATOR

- Элеватор корневой экстракционный
- Elévateurs à racines
- Wurzelheber
- Слеватор корневий экстракційний
- Elevadores para raices
- المصاعد الجذر

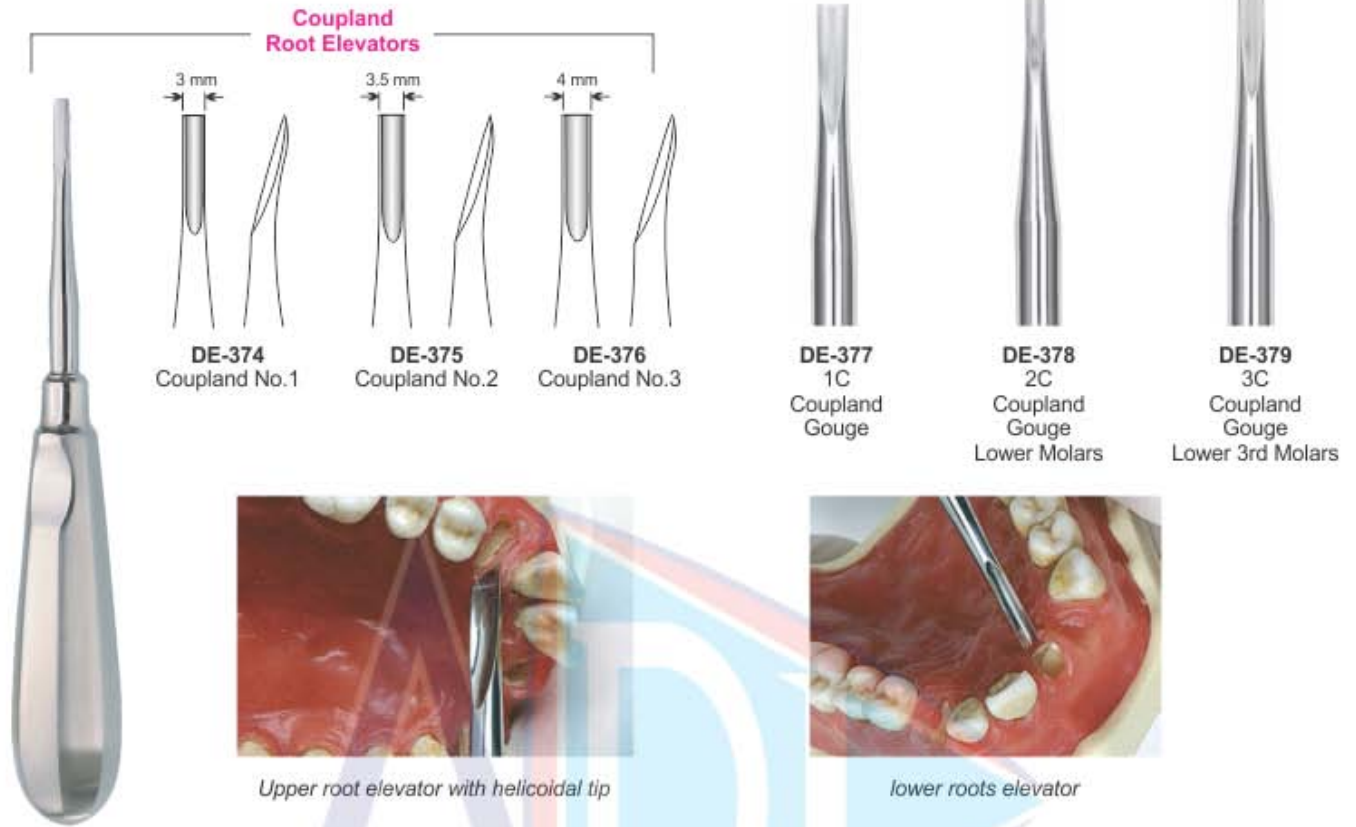

FUNCTION: To Loosen Tooth or Root From Bony Socket Prior to Placement of The Extraction Forceps.

ENGLISH PATTERNS



ROOT ELEVATOR



- Элеватор корневой экстракционный
- Elévateurs à racines
- Wurzelheber
- Слеватор корневий екстракційний
- Elevadores para raices
- المصاعد الجذر

Lindo Levian Root Elevators



DE-393
Lindo-Levian
Serrated Curved

DE-394
Lindo-Levian
Serrated Right

Function of Root Elevators:

To loosen tooth or root from bony socket prior to placement of the extraction forceps.



Bein
DE-395



Bein
DE-396



Bein
DE-397



Bein
DE-398



Gartner
DE-399



Gartner
DE-400



Gartner
DE-401

ROOT ELEVATOR

- Элеватор корневой экстракционный
- Elévateurs à racines
- Wurzelheber
- Слеватор корневий екстракційний
- Elevadores para raices
- المصاعد الجذر

Friedmann Roots Elevator



DE-402
Friedmann 4F
Str.

DE-403
Friedmann 5F
Left

DE-404
Friedmann 6F
Right

Luxating Elevator With Periotome Tip



DE-405
3mm Luxating
Elevator / Periotome

DE-406
4mm Luxating
Elevator / Periotome

DE-407
5mm Luxating
Elevator / Periotome

Wisdom Roots Elevator



DE-408
Wisdom
for 18 and 38

DE-409
Wisdom
for 28 and 48

Function of Root Elevators: To loosen tooth or root from bony socket prior to placement of the extraction forceps.

Bayonet Roots Elevator Set



DE-410
Left

DE-411
Right

DE-412
bayonet

DE-413
Curved

DE-414
Straight

ROOT ELEVATOR



- Элеватор корневой экстракционный
- Elévateurs à racines
- Wurzelheber

- Слеватор корневий экстракційний
- Elevadores para raices
- المعصاع الجذر

Miller Root Elevators



Function of Root Elevators: To loosen tooth or root from bony socket prior to placement of the extraction forceps.

Claw-Lift Roots Elevator

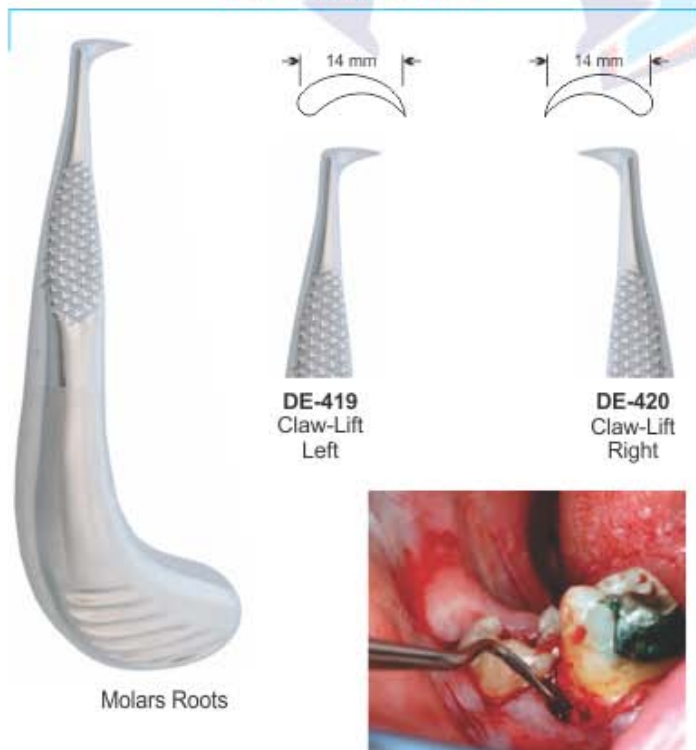

Schlemmer Roots Elevator





ROOT ELEVATOR

- Элеватор корневой экстракционный
- Elévateurs à racines
- Wurzelheber
- Слеватор корневий екстракційний
- Elevadores para raices
- المصاعد الجذر

FUNCTION: To Loosen Tooth or Root From Bony Socket Prior to Placement of The Extraction Forceps.

Laxutor Root Elevators Set of 9 Pcs



DE-424
2mm Str.



DE-425
3mm Str.



DE-426
5mm Str.



DE-427
3mm Cvd.



DE-428
5mm Cvd.



DE-429
3mm Angle



DE-430
3mm Angle



DE-431
3mm Str.



DE-432
5mm Str.



ROOT ELEVATOR

- Элеватор корневой экстракционный
- Elévateurs à racines
- Wurzelheber
- Слеватор корневий екстракційний
- Elevadores para raices
- المعاعد الجذر

Hylin Roots Elevator



Function of Root Elevators: To loosen tooth or root from bony socket prior to placement of the extraction forceps.

Kopp Roots Elevator



ROOT ELEVATOR

- Элеватор корневой экстракционный
- Elévateurs à racines
- Wurzelheber
- Слеватор корневий екстракційний
- Elevadores para raices
- المعصاع الجذر

Luxier Roots Elevator



DE-447
Luxier
Cvd.

DE-448
Luxier
Str.



Heber Roots Elevator



DE-449
Heber
Bayonet

DE-450
Heber
Bayonet



Bein Roots Elevator



DE-451
Bein,
3mm

DE-452
Bein,
4mm

Function of Root Elevators: To loosen tooth or root from bony socket prior to placement of the extraction forceps.

Bein Roots Elevator



DE-453
Bein
2mm, curved
serrated

DE-457
Bein
2mm, curved
serrated

DE-461
Bein
2mm, curved
serrated

ROOT ELEVATOR



- Элеватор корневой экстракционный
- Elévateurs à racines
- Wurzelheber
- Слеватор корневий екстракційний
- Elevadores para raices
- المصاعد الجذر

W. Barry Roots Elevator



W. Barry
Fig. 1
(125mm)



DE-465
W. Barry
Fig. 1



DE-466
W. Barry
Fig. 2



DE-467
W. Barry
Fig. 3



DE-468
W. Barry
Fig. 4



Function of Root Elevators: To loosen tooth or root from bony socket prior to placement of the extraction forceps.



Winter
Fig. 1L
125mm



DE-469
Winter
Fig. 1L



DE-470
Winter
Fig. 1R



DE-471
775/3
Winter
11 L



DE-472
775/4
Winter
11 R



DE-473
775/5
Winter
12 L



DE-474
775/6
Winter
12 R



DE-475
775/7
Winter
13 L



DE-476
775/8
Winter
13 R



DE-477
Winter
Fig. 1L



DE-478
Winter
Fig. 1R



DE-479
Lecluse
bayonet



DE-480
Potts "T-Handle"
Elevator-Left



DE-481
Potts "T-Handle"
Elevator-Right

ROOT ELEVATOR

- Элеватор корневой экстракционный
- Elévateurs à racines
- Wurzelheber
- Єлеватор корневий екстракційний
- Elevadores para raices
- المصاعد الجذر



DE-482
Fig. 1
Chompret



DE-483
Fig. 2
Chompret



DE-484
Fig. 3
Chompret



DE-485
Fig. 4
Chompret



Lecluse elevator for lower third molar dislocation



Chompret syndesmotome, sickle pattern



DE-486



DE-487



DE-488



DE-489



DE-490



DE-491



DE-492

Root Pick Elevator With Gold Flexible Points

ROOT ELEVATOR



- Элеватор корневой экстракционный
- Elévateurs à racines
- Wurzelheber
- Слеватор корневий екстракційний
- Elevadores para raices
- المصاعد الجذر

Heidbrink Roots Elevator



DE-493 Heidbrink Straight
 DE-494 Heidbrink Left
 DE-495 Heidbrink Right
 DE-496 Heidbrink Straight
 DE-497 Heidbrink Left
 DE-498 Heidbrink Right

Syndesmotomes Roots Elevator



DE-499 Straight
 DE-500 Left
 DE-501 Right

Periotome Roots Elevator



DE-502 Periotome 2.1mm Straight
 DE-503 Periotome 2.6mm Straight
 DE-504 Periotome 2.1mm Angular
 DE-505 Periotome 2mm Curved
 DE-506 Periotome 2.0mm
 DE-507 Periotome 2.5mm
 DE-508 Periotome 3.0mm
 DE-509 Periotome 4.0mm

Syndesmotomes

ROOT ELEVATOR

- Элеватор корневой экстракционный
- Elévateurs à racines
- Wurzelheber
- Слеватор корневий екстракційний
- Elevadores para raices
- المعاعد الجذر

FUNCTION: To loosen small root fragments from bony socket

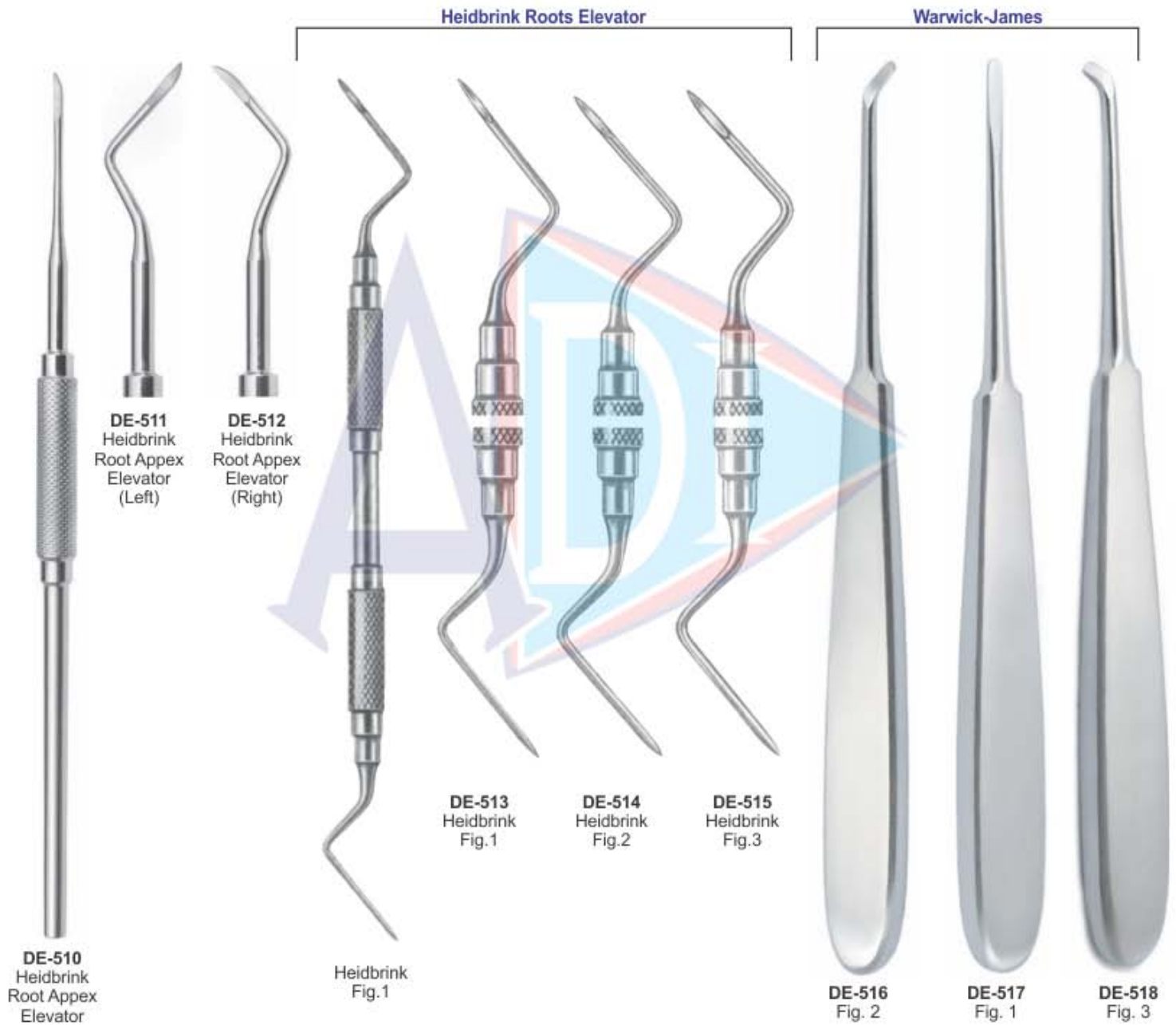

ROOT ELEVATOR



- Элеватор корневой экстракционный
- Elévateurs à racines
- Wurzelheber
- Слеватор корневий екстракційний
- Elevadores para raices
- المعاصر الجذر



DE-519
1S
(Straight 1mm)



DE-520
2S
(Straight 2mm)



DE-521
3S
(Straight 3mm)



DE-522
5S
(Straight 5mm)



DE-523
3C
(Curved 3mm)



DE-524
5C
(Curved 5mm)



DE-525
3CA
(Curved Angle 3mm)



DE-526
3IC
(Inverted Curved 3mm)



DE-527
DE 3
(Dual Edge 3mm / 1.5mm)



DE-528
DE 5
(Dual Edge 5mm / 3mm)



ROOT ELEVATOR

- Элеватор корневой экстракционный
- Elévateurs à racines
- Wurzelheber
- Єлеватор кореневий екстракційний
- Elevadores para raíces
- المصاعد الجذر



DE-529
Luxators Set of 7 Pcs

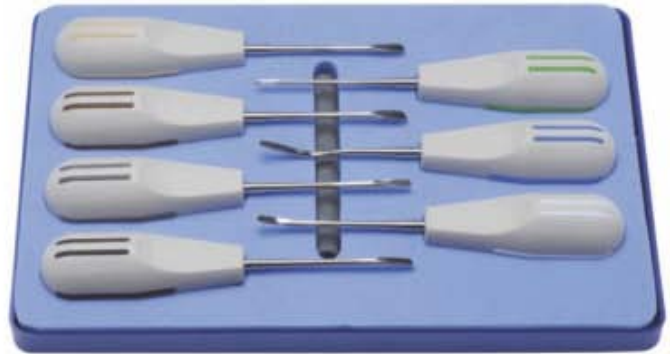

DE-530
Luxators Set of 7 Pcs



DE-531
Luxators Set of 8 Pcs



DE-532
Root Elevators Set of 10 Pcs



DE-533
Elevators Set of 8 Pcs



DE-534
Elevators Set of 8 Pcs

ROOT ELEVATOR



- Элеватор корневой экстракционный
- Elévateurs à racines
- Wurzelheber
- Elevator corneviu extracționii
- Elevadores para raíces
- المصاعد الجذر

PDL ELEVATORS

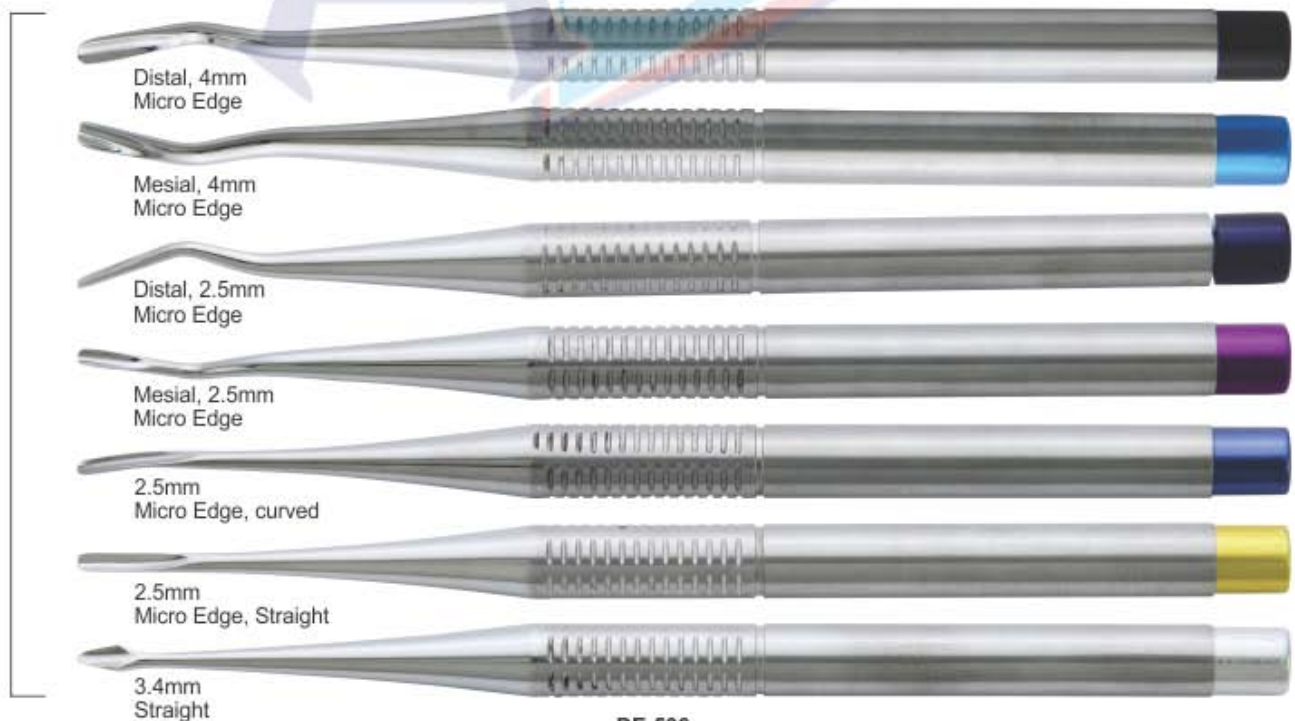
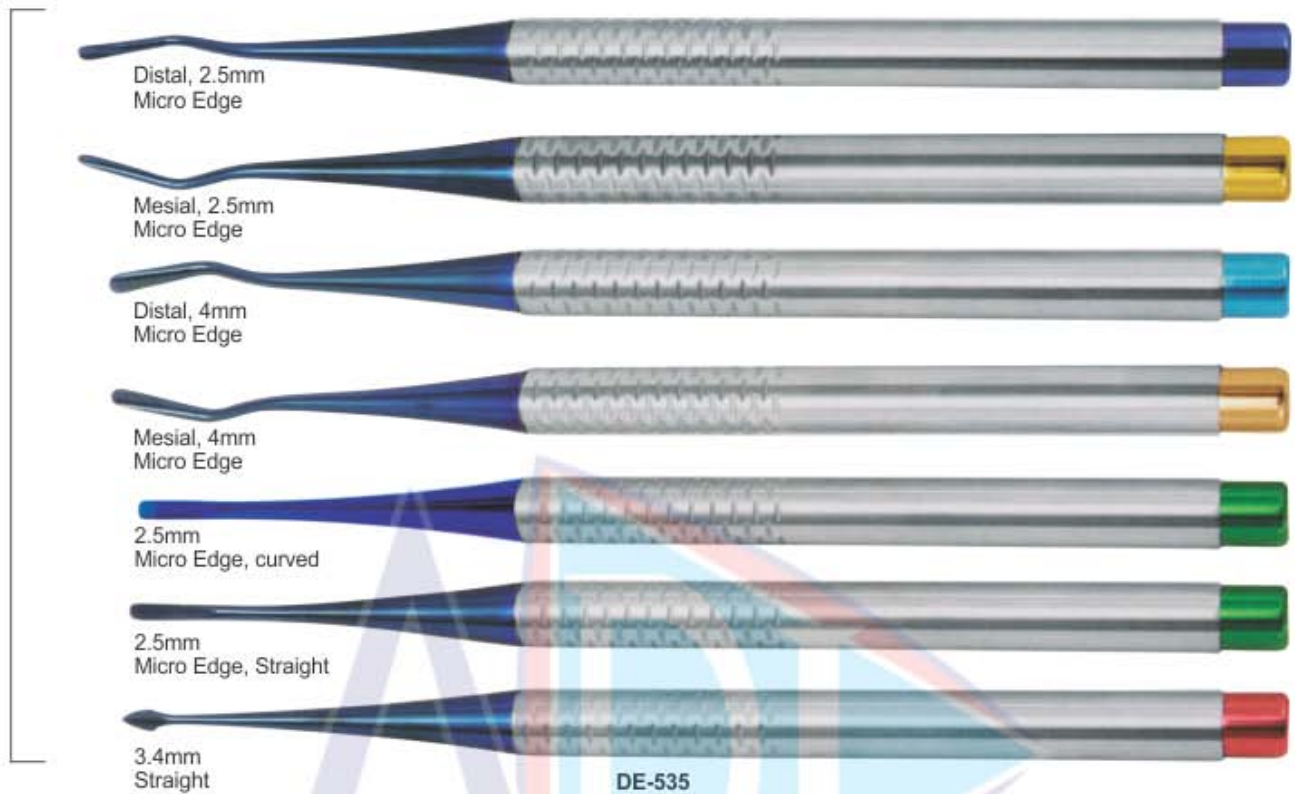



ROOT ELEVATOR

- Элеватор корневой экстракционный
- Elévateurs à racines
- Wurzelheber
- Слеватор корневий екстракційний
- Elevadores para raices
- المصاعد الجذر

PDL ELEVATORS

Delicate Arrow tip



4,0mm straight
4,0mm curved

Luxivators straight
atraumatic luxation of the tooth



2,5mm straight
3,5mm straight
4,5mm straight

Luxivators curved
atraumatic luxation of the tooth



2,5mm curved
3,5mm curved
4,5mm curved



DE-537
PDL Elevators
Set of 8 Pcs

Our Scalers

Compare our scalers and curettes with the best in the industry and you will immediately recognize we are equal in every way but one... price. Note the deep precision knurling for better tactile feel. The same high-grade stainless steel tips, the same light weight (under 18 grams) for less hand fatigue, the same professional craftsmanship, and surpassing the highest industry standards. of course, any manufacturer can make these claims, but we guarantee and certify ours.

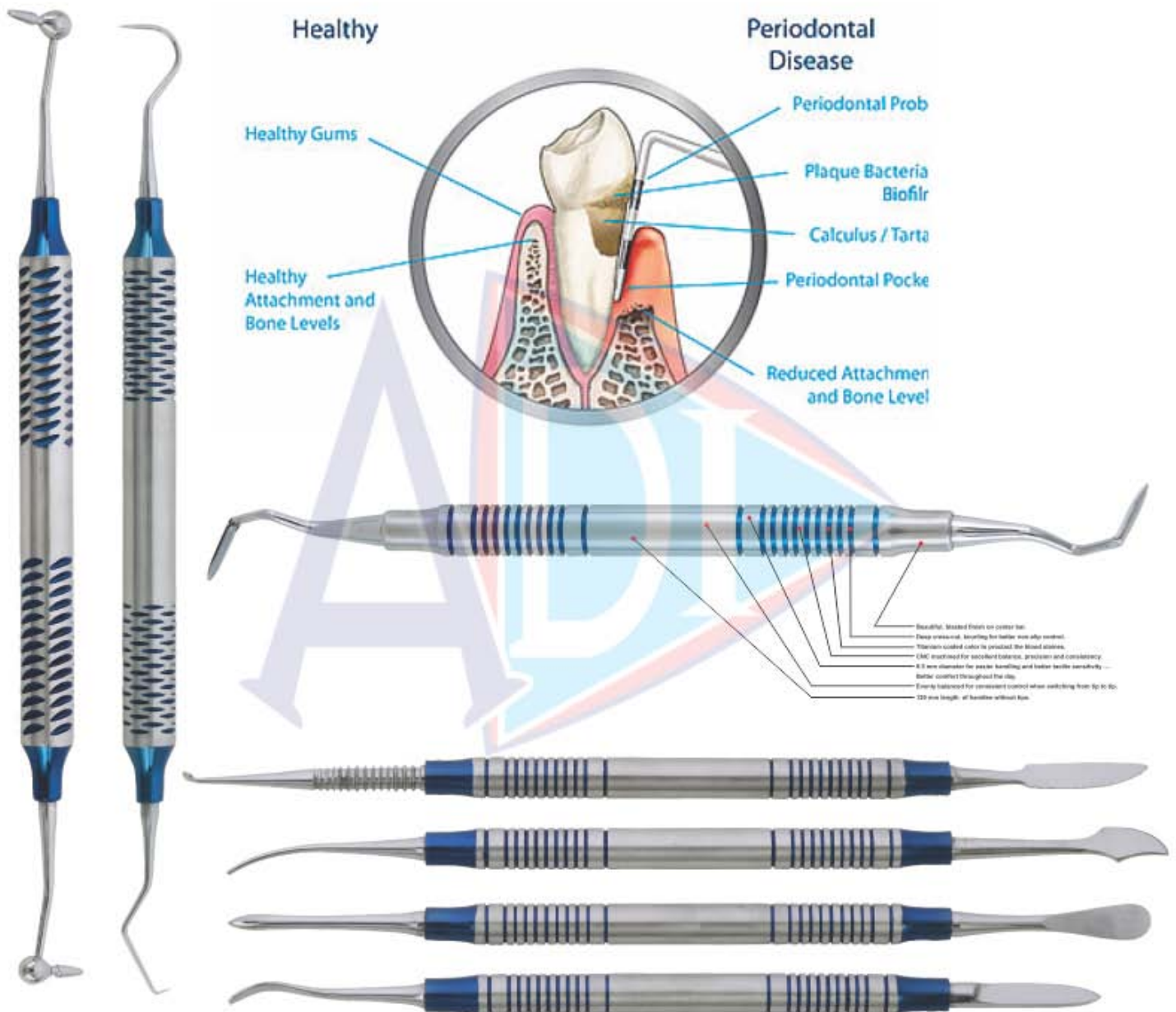

- High-polish mirror finish tips.
- Manufactured within the guidelines of the FDA quality assurance system for good manufacturing practices.
- Highest grade German stainless steel, razor sharp, durable tips. Rockwell hardened to 60 RHc.
- 27 of the most popular designs from graces to McCalls to columbias, and many european patterns.
- All instruments are guaranteed against defects in material and workmanship.

- All instruments bear the ce mark, emblematic of the european community's highest standards.
- Customer satisfaction guarantee, too!
- Less than 20 grams ... Lightweight for less hand fatigue.
- Manufactured to the most exacting standards so the 50th instrument you buy is exactly like your first.
- You decide ... Why pay more for the same high-quality instruments?



DIAGNOSTIC, PERIODONTAL & RESTORATIVE INSTRUMENTS

VALUED BUYERS

Compare our scalers and curettes with the best in the industry and you will immediately recognize we are equal in every way but one... price. Note the deep precision knurling for better tactile feel. The same high-grade stainless steel tips, the same light weight (under 20 grams) for less hand fatigue, the same professional craftsmanship, and surpassing the highest industry standards. Of course, any manufacturer can make these claims, but we guarantee and certify ours. We regularly manufacturing below articles in showing handles & pattern A to L for better grip & perfection. We are also fully equipped & capable to develop these instruments as per your own specific requirements & demands in materials, sizes, shapes and patterns.



A-Hollow Handle Ø 10 mm



B-Hollow Handle Ø 10 mm



C-Hollow Handle Ø 10 mm



D-Hollow Handle Ø 10 mm



E-Hollow Handle Ø 10 mm



F-Hollow Handle Ø 10 mm



G-Hollow Handle Ø 10 mm



H-Hollow Handle Ø 6.4 mm



I-Hollow Handle Ø 8 mm



J-Hollow Handle Ø 10 mm



K-Soild Handle Ø 6 mm



L-Soild Handle Ø 6 mm

MOUTH MIRRORS



- зеркал
- Espejos de la boca
- Mundspiegel
- дзеркал
- Miroirs à la bouche
- مرآيا الفم

Plain



DE-600 Fig. 3 Ø20mm
 DE-601 Fig. 4 Ø22mm
 DE-602 Fig. 5 Ø24mm
 DE-603 Fig. 6 Ø26mm

Cone-Socket Plain



DE-604 Fig. 3 Ø20mm
 DE-605 Fig. 4 Ø22mm
 DE-606 Fig. 5 Ø24mm

Magnifying



DE-607 Fig. 3 Ø20 mm
 DE-608 Fig. 4 Ø22 mm
 DE-609 Fig. 5 Ø24 mm

Cone-Socket Magnifying



DE-610 Fig. 3 Ø20mm
 DE-611 Fig. 4 Ø22mm
 DE-612 Fig. 5 Ø24mm

Rhodium



DE-613 Fig. 3 Ø20mm
 DE-614 Fig. 4 Ø22mm
 DE-615 Fig. 5 Ø24 mm

Cone-Socket Rhodium



DE-616 Fig. 3 Ø20mm
 DE-617 Fig. 4 Ø22mm
 DE-618 Fig. 5 Ø24mm

Front Surface



DE-619 Fig. 3 Ø20mm
 DE-620 Fig. 4 Ø22mm
 DE-621 Fig. 5 Ø24mm
 DE-622 Fig. 6 Ø26mm

Cone-Socket Front Surface



DE-623 Fig. 3 Ø20mm
 DE-624 Fig. 4 Ø22mm
 DE-625 Fig. 5 Ø24mm



HANDLES FOR MOUTH MIRRORS

- Ручки для зеркал
- Manches pour miroirs à bouche
- Mundspiegelgriffe
- Ручки для дзеркал
- Mangos para espejos de boca
- مقابض لمرآيا الفم



DE-626
Hollow Mirror
Handle Round
Ø 10 mm



DE-627
Hollow Mirror
Hexagonal
Handle
Ø 8 mm



DE-628
Hollow
Ø 8 mm



DE-629
Hollow Mirror
Hexagonal
Handle
Ø 10 mm



DE-630
Hollow Mirror
Handle
Ø 8 mm



DE-631
Hollow Mirror
Handle
Ø 10 mm



DE-632
Mirror Handle
Solid
Ø 6 mm



DE-633
Mirror Handle
Solid
Ø 6 mm



DE-634
Mirror Handle
Solid Octagonal
Ø 6 mm



DE-635
Mirror Handle
Stem
with Rule
35mm



DE-636
Mirror Handle
Solid
Stem with
Rule 35mm



DE-637
Cone-Socket
Solid Octagonal
Ø 6 mm



DE-638
Cone-socket
Solid
Ø 6 mm



DE-639
Cone-socket
Hexagonal
Handle
Ø 6 mm

Cone-Socket Mirror Handle

EXPLORERS



- Зонды
- Sondes
- Zahnsonden
- Зонди
- Sondas
- المستكشفين

Examination kit Set of 3 Pieces



DE-640 Probe
DE-641 Mirror
DE-642 College Forcep 15cm



Examination Set of 4 Pieces



DE-643 Exp,23/17-A
DE-644 Exavators
DE-645 Tweezers
DE-646 Mouth Mirror

DE-647

First Aid Examination Set of 3 Pieces



DE-648

First Aid Examination Set of 3 Pieces



DE-649

First Aid Examination Set of 3 Pieces



DE-650

First Aid Examination Set of 3 Pieces





TWEEZERS

- Пинцеты
- Précelles - Brucelles
- Zahnpinzetten

- Пинцети
- Pinzas para algodón
- ملاقط



DE-651
Surgical
11.5cm



DE-652
London College
15cm



DE-653
Semken Taylor
Str.



DE-654
Semken Taylor
Cvd.



DE-655
Meriam
16cm



DE-656
Dressing
14cm



DE-657
Semken Taylor
1x2 Straight



DE-658
Semken Taylor
1x2 Curved



DE-659
Gilles
15cm 1x2



DE-660
14cm 1x2



DE-661
Perry
13cm



DE-662
Atraumatic
15cm Cvd.



DE-663
Atraumatic
15cm Str.



DE-664
College with Lock
15cm Cvd.



DE-665
Gerald
17.5cm



DE-666
with lock
15cm



DE-667
Atraumatic
17.5cm

TWEEZERS



- Пинцеты
- Précettes - Brucelles
- Zahnpinzetten

- Пинцети
- Pinzas para algodón
- ملاقط



DE-668
Adson-TC
12cm



DE-669
Adson-TC
12cm 1x2



DE-670
Adson-TC
15cm 1x2



DE-671
Adson
12cm



DE-672
Adson
12cm 1x2



DE-673
Adson
15cm 1x2



DE-674
Adson Brown
12cm



DE-675
Crane Kaplan
15cm



DE-676
Crane Kaplan
15cm



DE-677
Crane Kaplan
15cm



DE-678
Hemingway
15cm



DE-679
Miller
15cm Str.



DE-680
Miller
15cm Cvd.



DE-681
Dressing
Tweezer
14.5cm



DE-682
College
Curved
Tip 15cm



DE-683
Maryam
Tweezers
15cm



DE-684
College
Tweezer
15cm



DE-685
Perry
Tweezer
12.5cm



DE-686
Self-locking
Tweezer
15cm

EXPLORERS

- Зонды
- Sondes
- Zahnsonden
- Зонди
- Sondas
- المستكشفين

Single Ended Probe Solid Handle 4.5mm Length 150mm

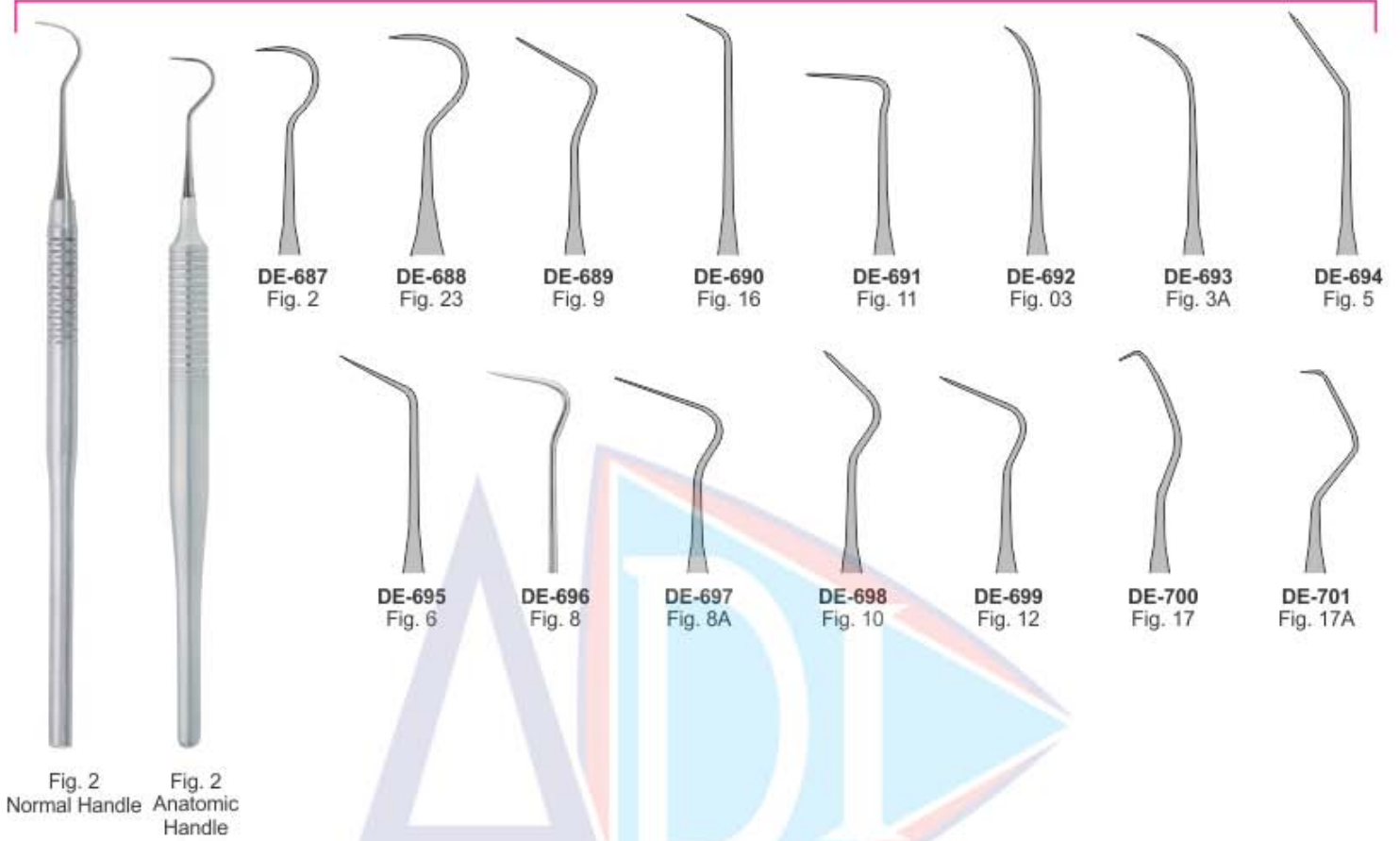

Explorers-Single-End

Double-Ended Explorers

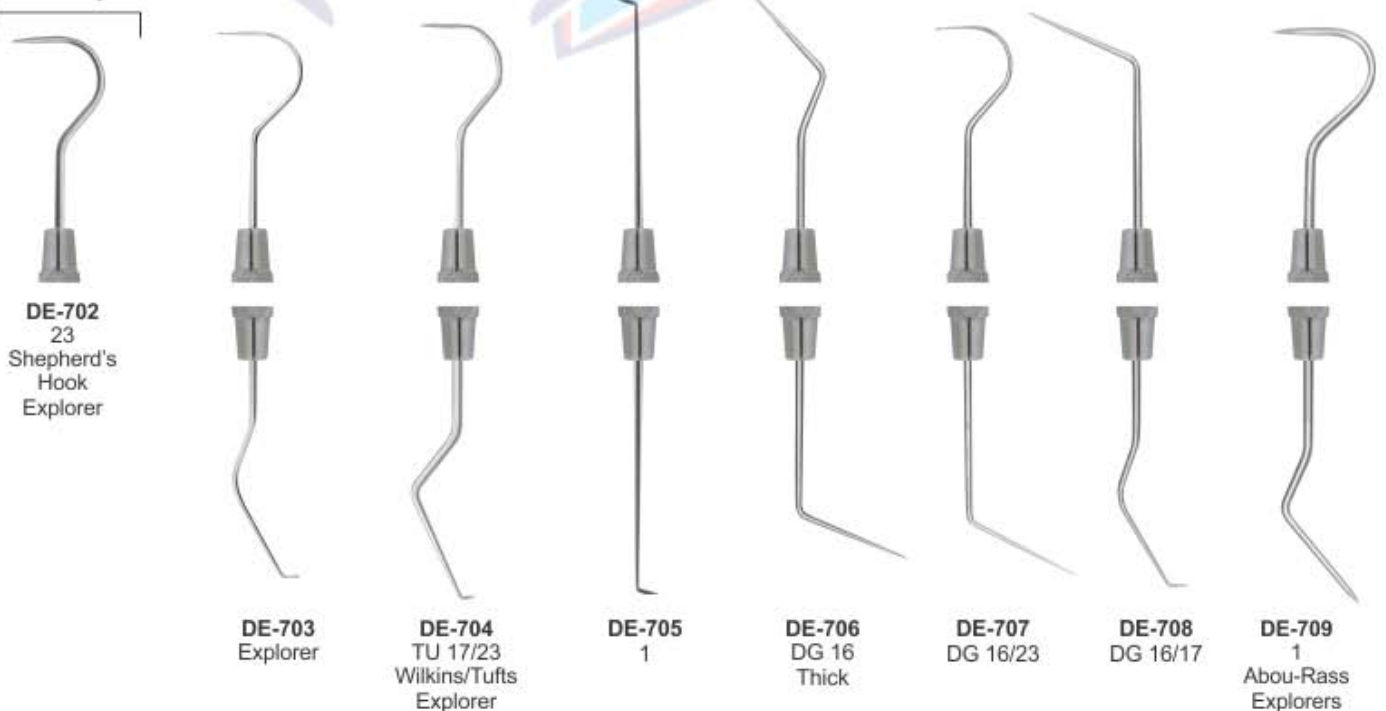

EXPLORERS



- Зонды
- Sondes
- Zahnsonden
- Зонди
- Sondas
- المستكشفين

Probes Double Ended 6mm, length 170mm

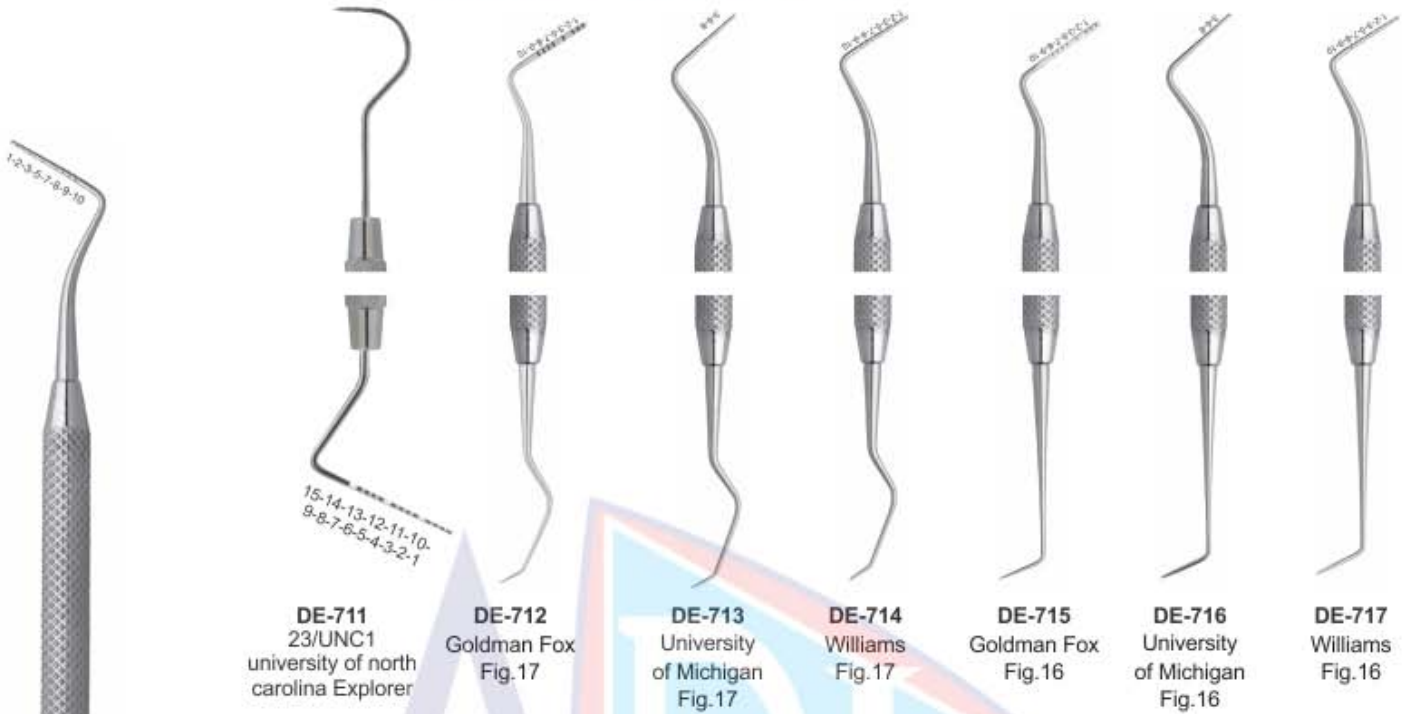

Pointed Probes Double Ended Handle 6mm, length 170mm

DE-710
Williams

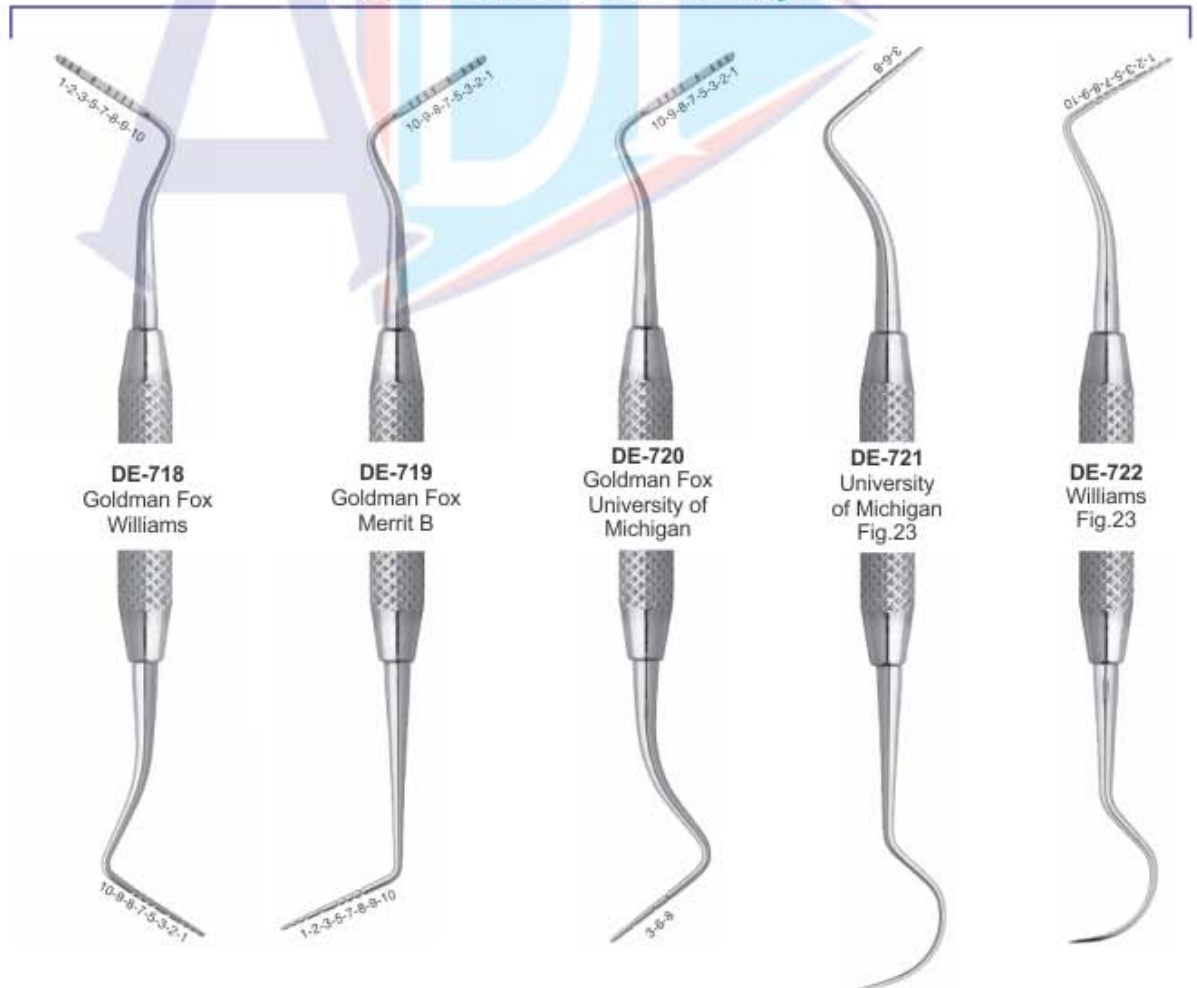



EXPLORERS

- Зонды
- Sondes
- Zahnsonden
- Зонди
- Sondas
- المستكشفين

EXPLORERS INSTRUMENTS SOLID HANDLE 6MM, LENGTH 170MM

PLUGGERS



<p>.50</p> <p>DE-724 5/7 21mm</p>	<p>1.00</p> <p>DE-725 9/11 21mm</p>	<p>.50</p> <p>DE-726 1/2 Root Canal Plugger</p>	<p>.80</p> <p>DE-727 3/4 Root Canal Plugger</p>
<p>.75</p> <p>DE-723 1/3 21mm</p>	<p>1.15</p> <p>DE-728 MA57 27mm</p>	<p>.60</p> <p>DE-729 GP3 30mm</p>	
<p>.30</p> <p>DE-730 ISO Size 30 24mm</p>	<p>.40</p> <p>DE-731 ISO Size 40 24mm</p>	<p>.50</p> <p>DE-732 ISO Size 50 24mm</p>	<p>.60</p> <p>DE-733 ISO Size 60 24mm</p>

PERIODONTAL PROBES



- Зонды пародонтологические
 - Sondes paradontales
 - sonde parodontali
- зонди пародонтологічні
 - Sondas paradontales
 - المسابر اللثة

SPREADERS

HEAT CARRIERS

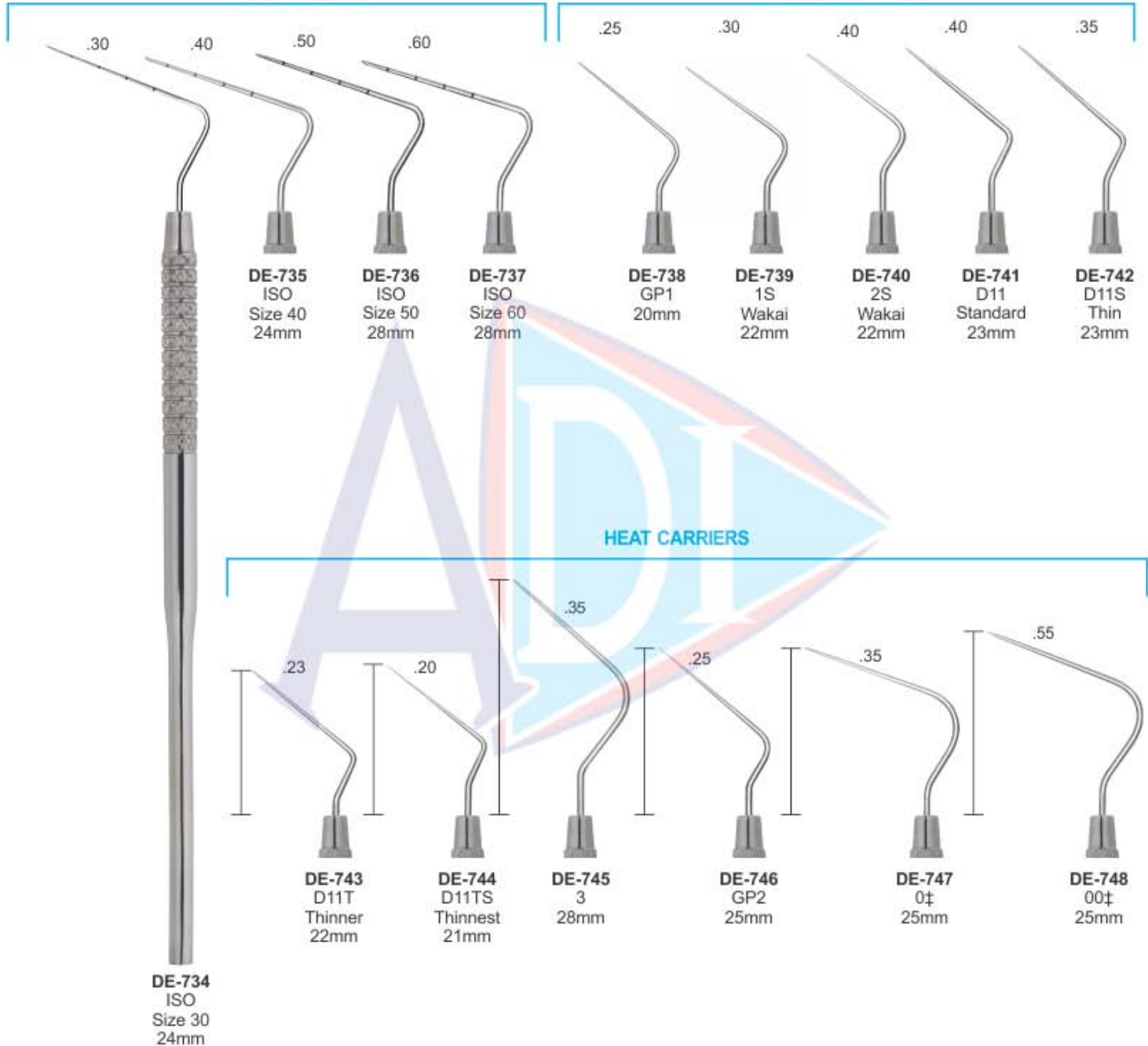

PERIODONTAL PROBES

- Зонды пародонтологические
- Sondes parodontales
- sonda parodontali
- зонди пародонтологічні
- Sondas parodontales
- المسابر اللثة

ENDODONTICS INSTRUMENTS

ANTERIOR

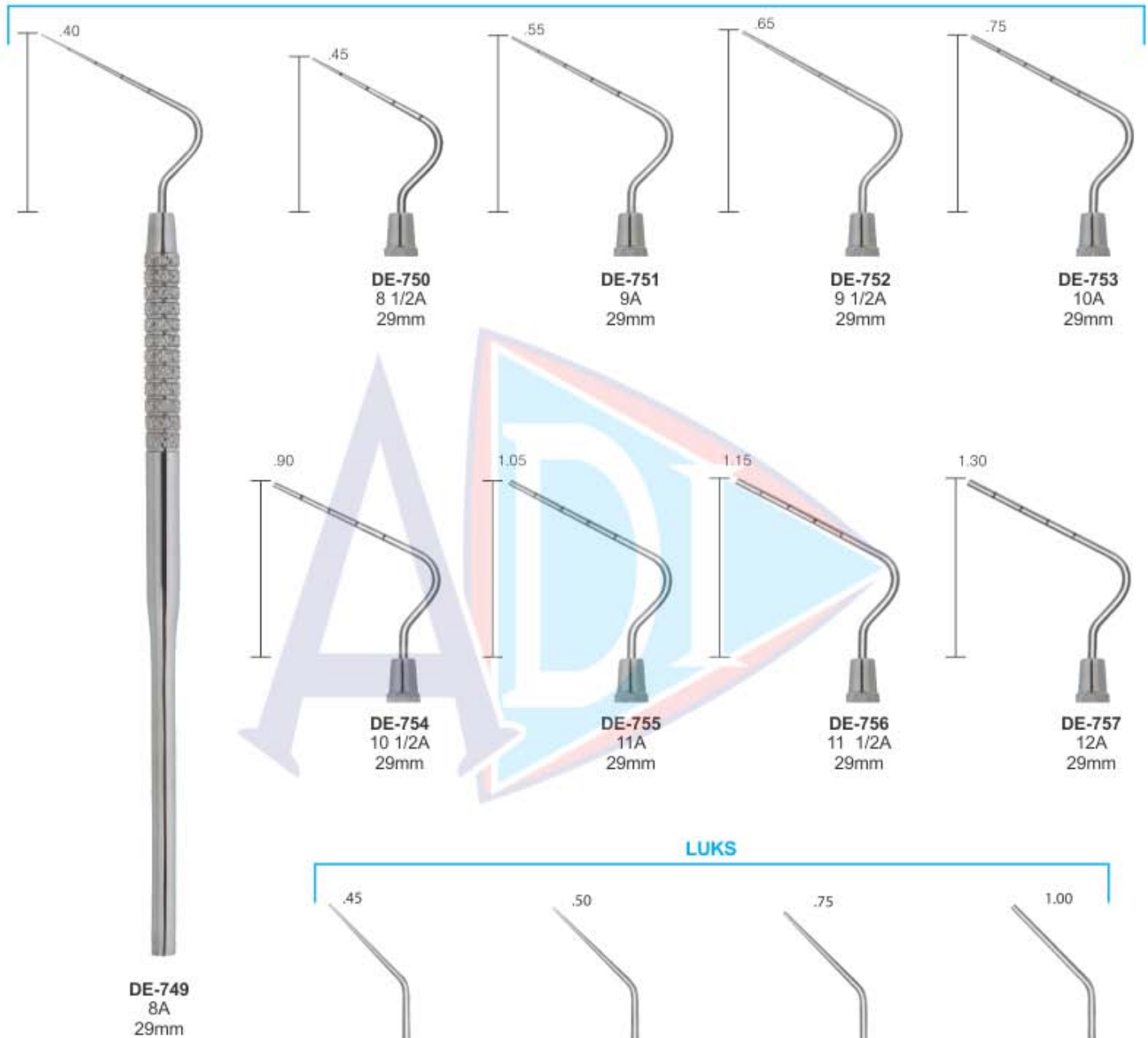

LUKS





DE-762
Gracey Curettes 1/2



DE-763
Gracey Curettes 3/4



DE-764
Gracey Curettes 5/6



DE-765
Gracey Curettes 7/8



DE-766
Gracey Curettes 9/10



DE-767
Gracey Curettes 11/12



DE-768
Gracey Curettes 13/14



DE-769
Gracey Curettes 1/2



DE-770
Gracey Curettes 3/4



DE-771
Gracey Curettes 5/6



DE-772
Gracey Curettes 7/8



DE-773
Gracey Curettes 9/10



DE-774
Gracey Curettes 11/12



DE-775
Gracey Curettes 13/14





SCALER

GRACEY MINI FIVE

Hollow Handle 9.5mm, Length 170mm Ceramic Coated Handle



DE-777
Fig. 3/4 Gracey 3M



DE-778
Fig. 5/6 Gracey 3M



DE-779
Fig. 7/8 Gracey 3M
Buccal and lingual/
Palatal surfaces



DE-780
Fig. 11/12 Gracey 3M
Mesial



DE-781
Fig. 13/14 Gracey 3M
Distal

DE-776
Fig. 1/2
Gracey 3m



GRACEY AFTER FIVE

Hollow Handle 9.5mm, Length 170mm Ceramic Coated Handle



DE-783
Gracey 3/4 AF



DE-784
Gracey 5/6 AF



DE-785
Gracey 7/8 AF



DE-786
Gracey 11/12 AF



DE-787
Gracey 13/14 AF

DE-782
Gracey
1/2 AF



Gracey Curettes



$\frac{3...1}{3...1} | \frac{1...3}{1...3}$ **DE-788** Fig. 1/2 GR - Gracey
Buccal surfaces



$\frac{5...1}{5...1} | \frac{1...5}{1...5}$ **DE-789** Fig. 3/4 GR - Gracey
Lingual/Palatal surfaces



$\frac{5...1}{5...1} | \frac{1...5}{1...5}$ **DE-790** Fig. 5/6 GR - Gracey



$\frac{8...4}{8...4} | \frac{4...8}{4...8}$ **DE-791** Fig. 7/8 GR - Gracey
Buccal and lingual/
palatal surfaces



$\frac{8...4}{8...4} | \frac{4...8}{4...8}$ **DE-792** Fig. 9/10 GR - Gracey
Buccal and lingual/
palatal surfaces more angled

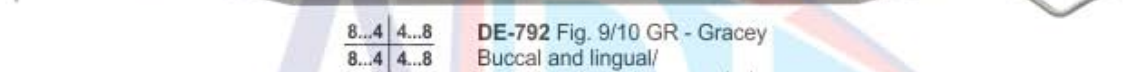

$\frac{8...4}{8...4} | \frac{4...8}{4...8}$ **DE-793** Fig. 11/12 GR - Gracey
Mesial

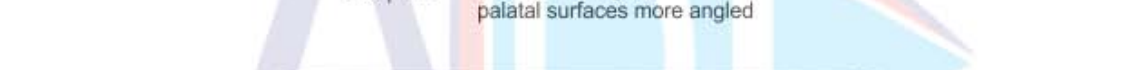

$\frac{8...4}{8...4} | \frac{4...8}{4...8}$ **DE-794** Fig. 13/14 GR - Gracey
Distal



$\frac{8...4}{8...4} | \frac{4...8}{4...8}$ **DE-795** Fig. 15/16 GR - Gracey
Mesial



$\frac{8...4}{8...4} | \frac{4...8}{4...8}$ **DE-796** Fig. 17/18 GR - Gracey
Distal

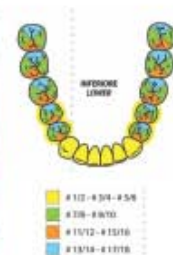
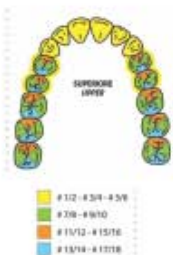
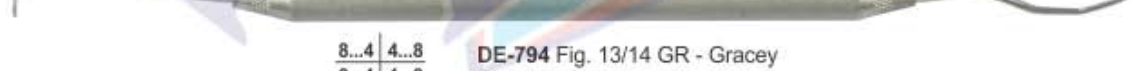

SCALER

Sickle Scalars



DE-797 Fig. U15/33 - Towner-Jaquette



DE-798 Fig. U15/30 - Towner-Jaquette



DE-799 Fig. H5/33



DE-800 Fig. H6/H7



DE-801 Fig. 30/33 - Jaquette



DE-802 Fig. T2/T3 - Taylor



DE-803 Fig. 204



DE-804 Fig. 204S



DE-805 Fig. 11/12 - MC - McCall
Mesial



DE-806 Fig. 13/14 - MC - McCall
Distal



Straight and curved sickle scalars
Feature: 2 cutting edges curved facial component tipped ends

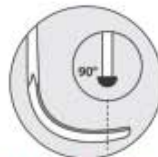

Universal curettes
are characterized by an angle of 90° between the terminal stem and the cutting component.

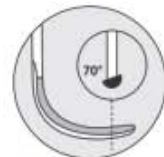

Gracey curettes
are characterized by an angle of 70° between the terminal stem and the cutting component.

Universal Curettes



DE-807 Fig. 13S/14S - MC - McCall



DE-808 Fig. 17S/18S - MC - McCall
Distal



DE-809 Fig. M23



DE-810 Fig. 204SD



DE-811 Fig. YG7/8-Younger Good



DE-812 Fig. L 1/2 - Langer



DE-813 Fig. L 3/4 - Langer



DE-814 Fig. L 5/6 - Langer



DE-815 Fig. M 23A



DE-816 Fig. M 23B

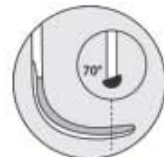
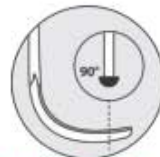
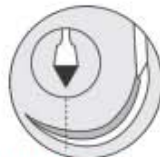
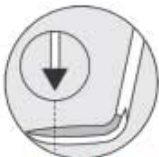

Straight and curved sickle scalers

Feature: 2 cutting edges curved facial component tipped ends

Universal curettes

are characterized by an angle of 90° between the terminal stem and the cutting component.

Gracey curettes

are characterized by an angle of 70° between the terminal stem and the cutting component.

Periodontal knives





DE-825
17



DE-826
17D



DE-827
54A
Mühlemann



DE-828
67



DE-829
37D



DE-830
8
Wiland



DE-831
8
Holz

0.9 MM



DE-832
9
Holz

0.7 MM

Chisels
Diamond coated margin trimmers



DE-833
40P



DE-834
40A

Thanks to the diamond-coated hand instruments the margins are evenly levelled.

Margin trimmers



DE-835
1TH2 Hirt



DE-836
5TH6 Hirt



DE-837
3TH4 Hirt



DE-838
7TH8 Hirt



DE-839
62NS61

2.0 MM

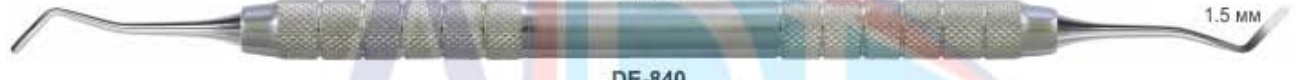

DE-840
37NS36

1.5 MM

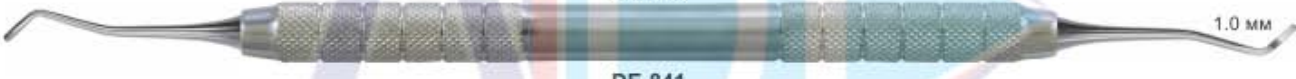

DE-841
66NS65

1.0 MM

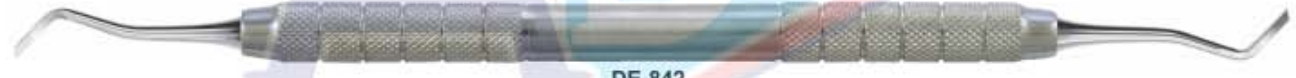

DE-842
79CI180 Black

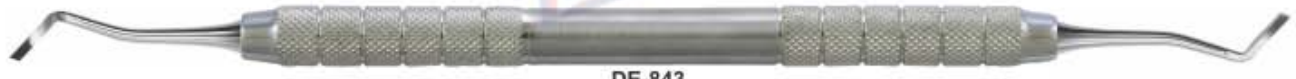

DE-843
77CI178 Black



DE-844
279CI280 Black



DE-845
277CI278 Black



DE-846
179CI180 Black



DE-847
177CI178 Black

CHISELS



DE-848
1/2 Werdelstaedt



DE-849
3/4 Werdelstaedt



DE-850
7 Straight



DE-851
5/6 Straight



DE-852
7/10 Straight



DE-853
8/9 Binangle



DE-854
11/12 Binangle



DE-855
40/41 Binangle

Tartar Remover Instruments Solid Handle Ø 6 mm



DE-856
Fig. 1

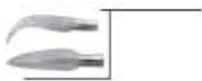

DE-857
Fig. 1L
Left



DE-858
Fig. 1R
Right



DE-859
Fig. 2L
left



DE-860
Fig. 2R
Right



DE-861



DE-862



DE-863

BURNISHERS CONSERVATIVE TREATMENT







FILLING INSTRUMENTS CONSERVATIVE TREATMENT

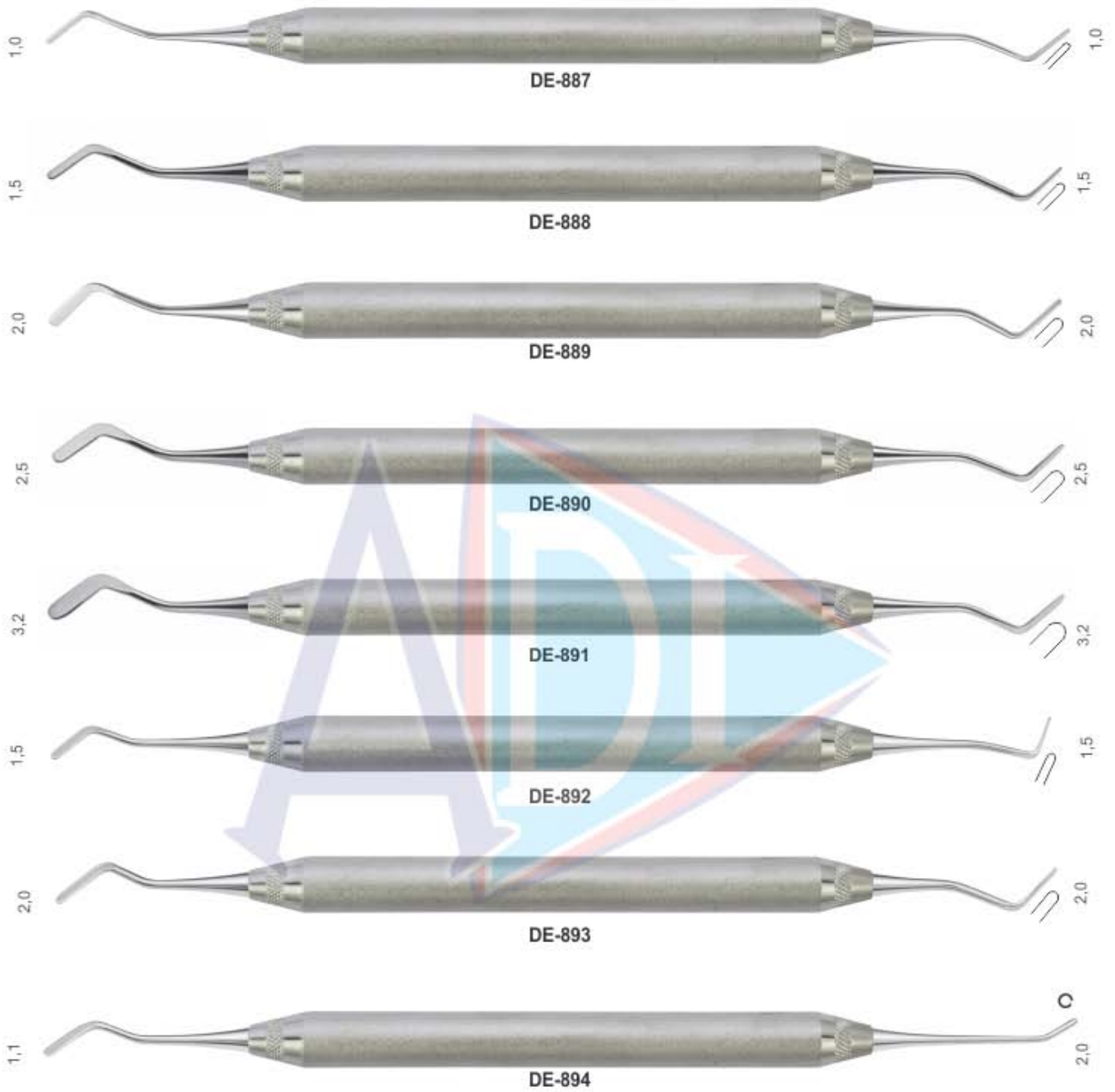

Ball Burnishers



DE-895



DE-896



DE-897



DE-898



Hatches



DE-899



DE-900



DE-901
Mini-Spatel



DE-902
Mini-Spatel



COMPOSITE INSTRUMENTS

Spatulas rounded and sharp

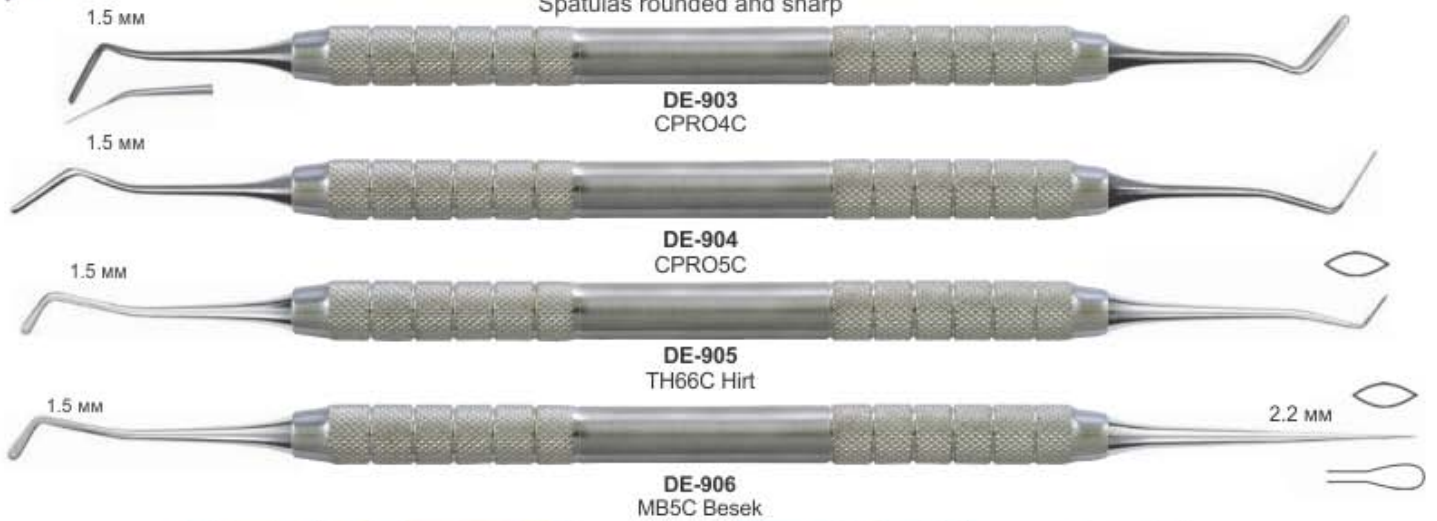

Spatulas Blade Thickness 0.22 mm



Spatulas

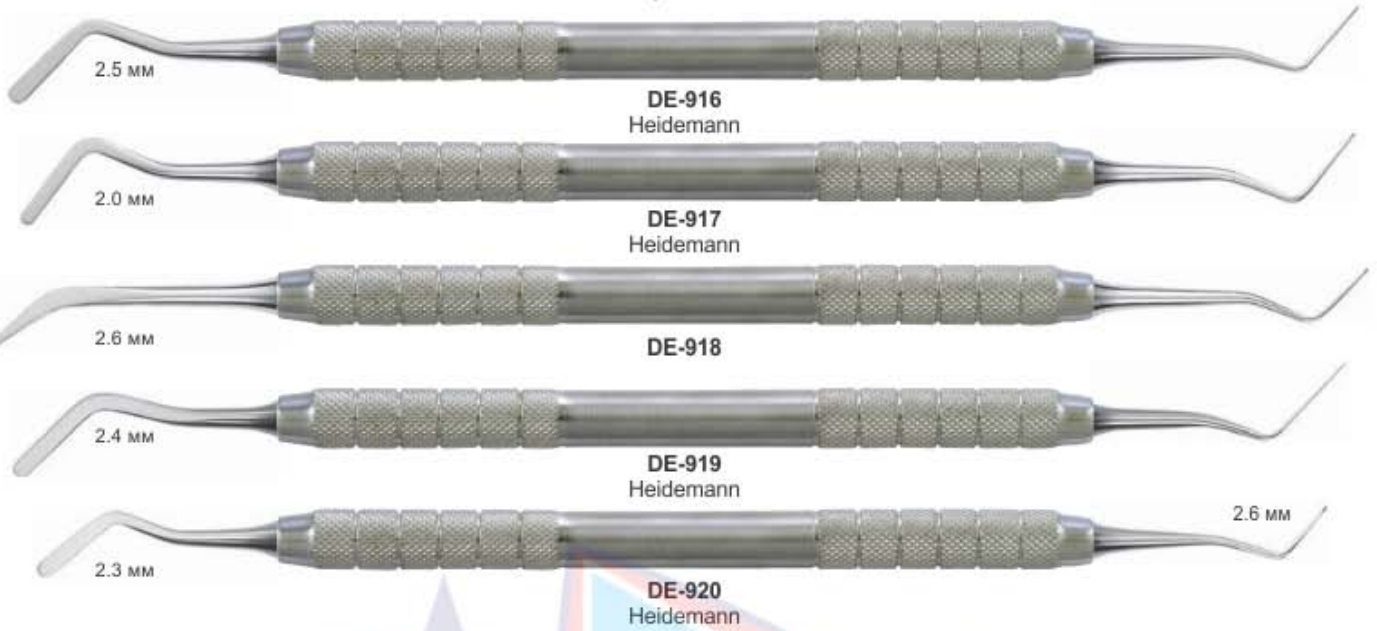

Spatulas-Pluggers

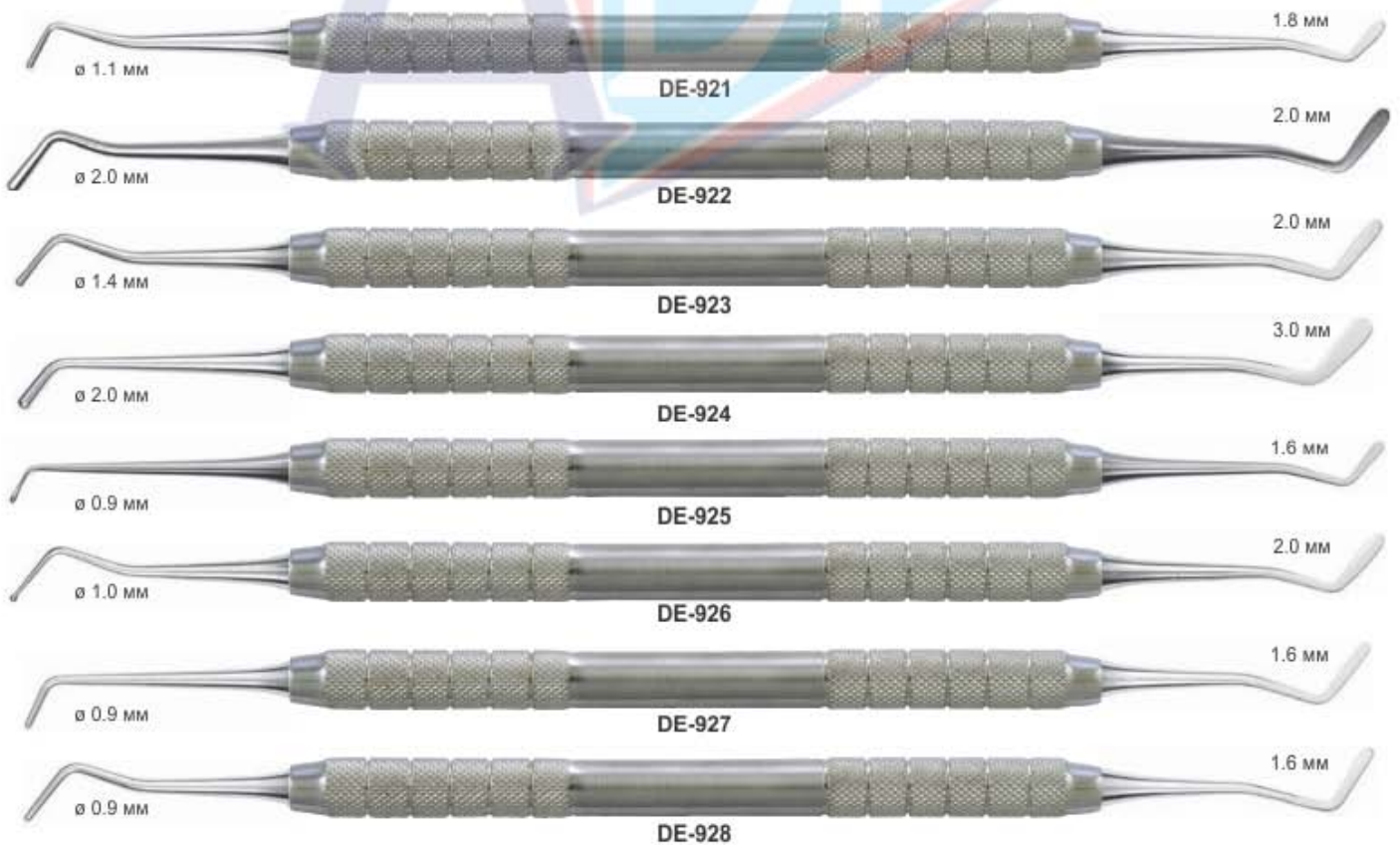



EXCAVATOR INSTRUMENTS

Water drop Our excavators have particularly sharp blades, free of burrs and perfectly rounded.



DE-929
0.8 MM



DE-930
0.8 MM



DE-931
0.8 MM



DE-932
1.1 MM



DE-933
1.1 MM



DE-934
1.2 MM



DE-935
1.2 MM

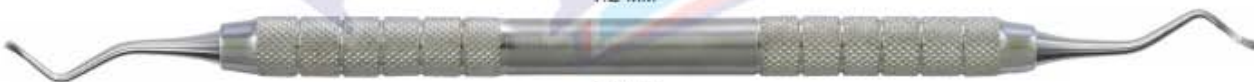

DE-936
1.4 MM



DE-937
1.6 MM



DE-938
1.9 MM



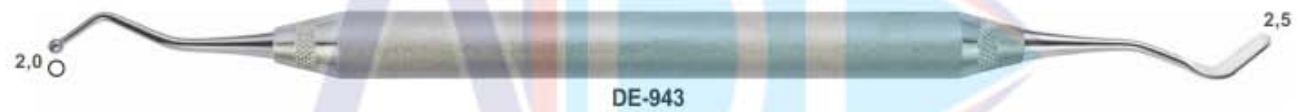



COMPOSITE BALL PLUGGERS

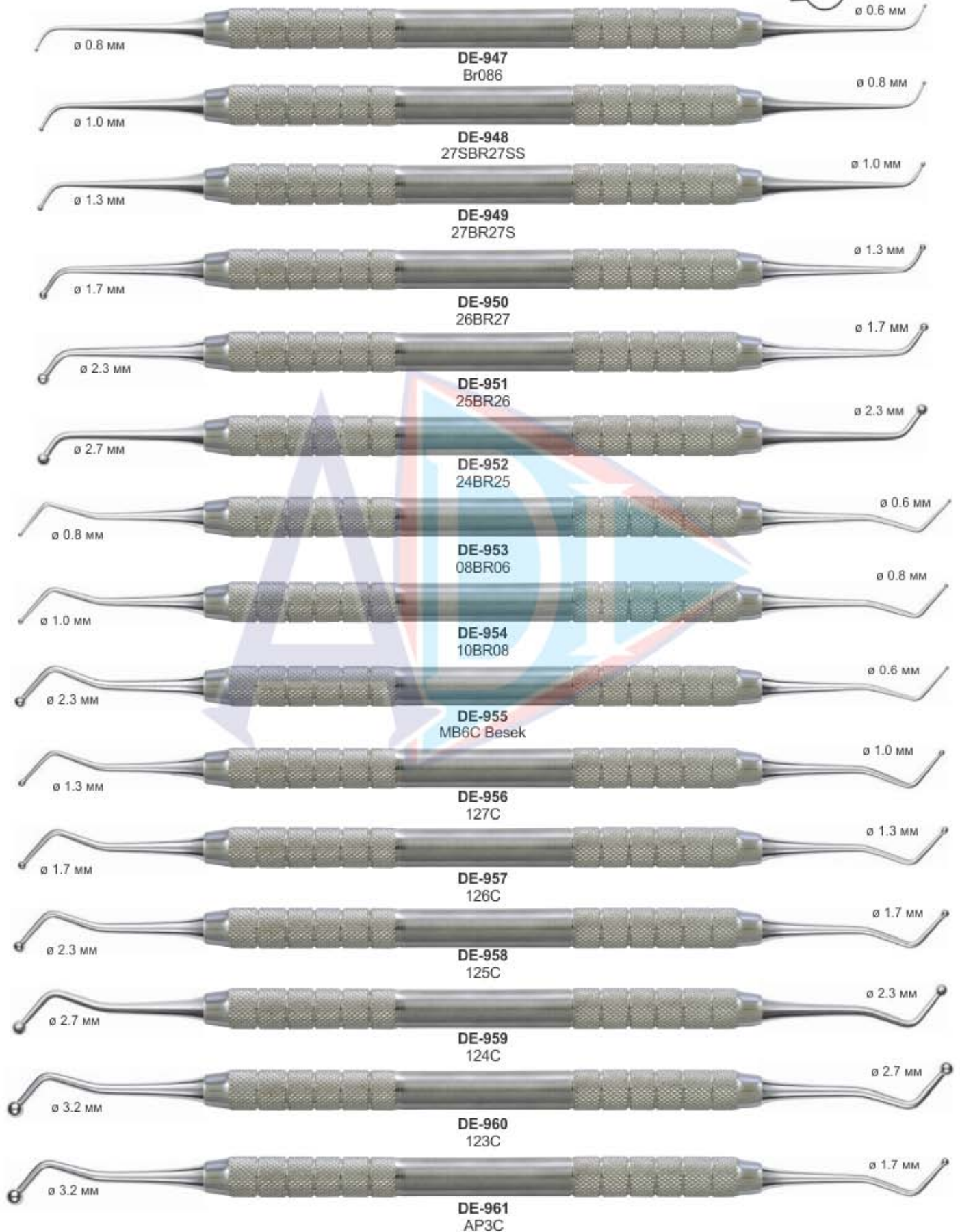

FILLING INSTRUMENTS CONSERVATIVE TREATMENT

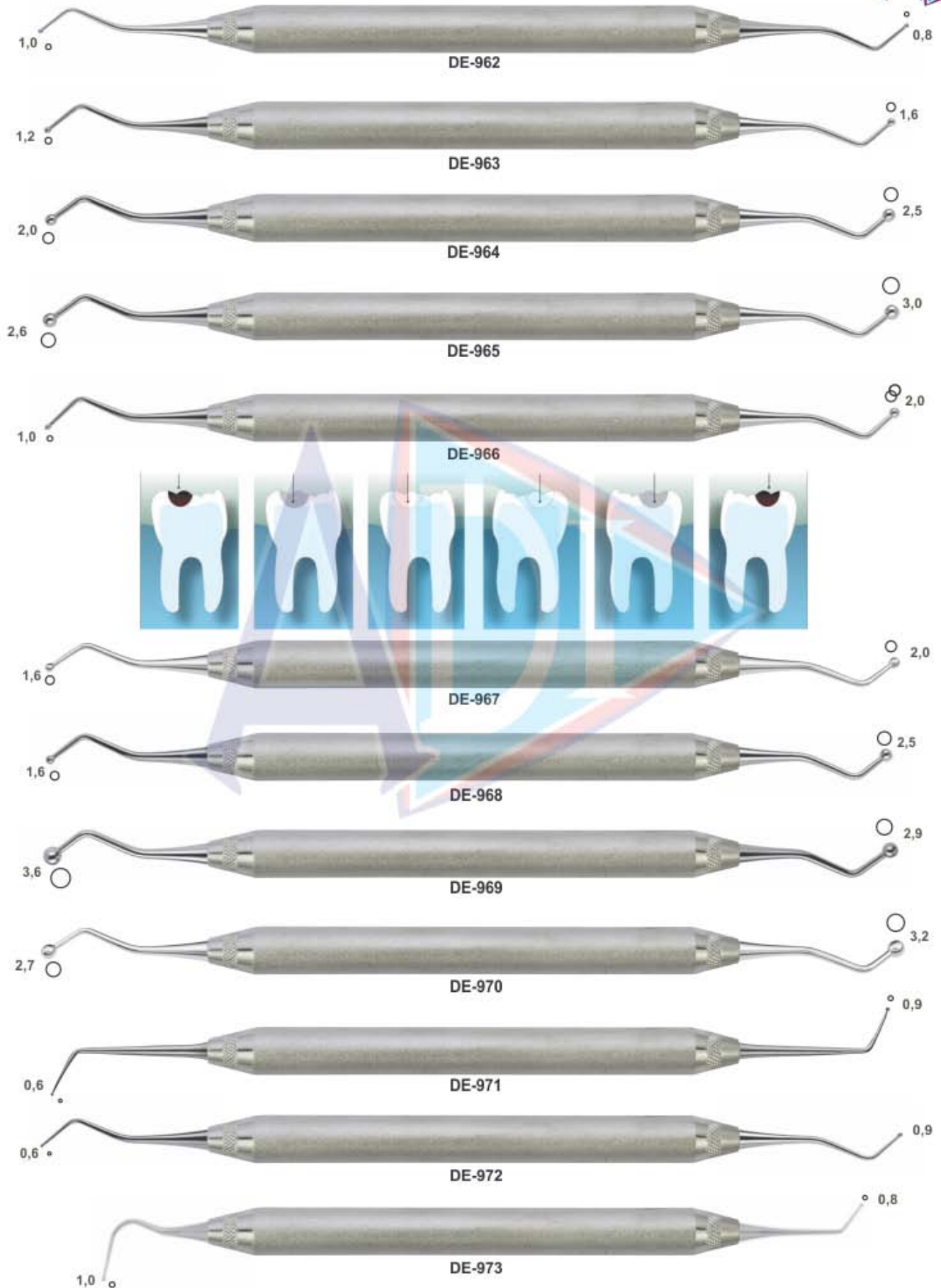

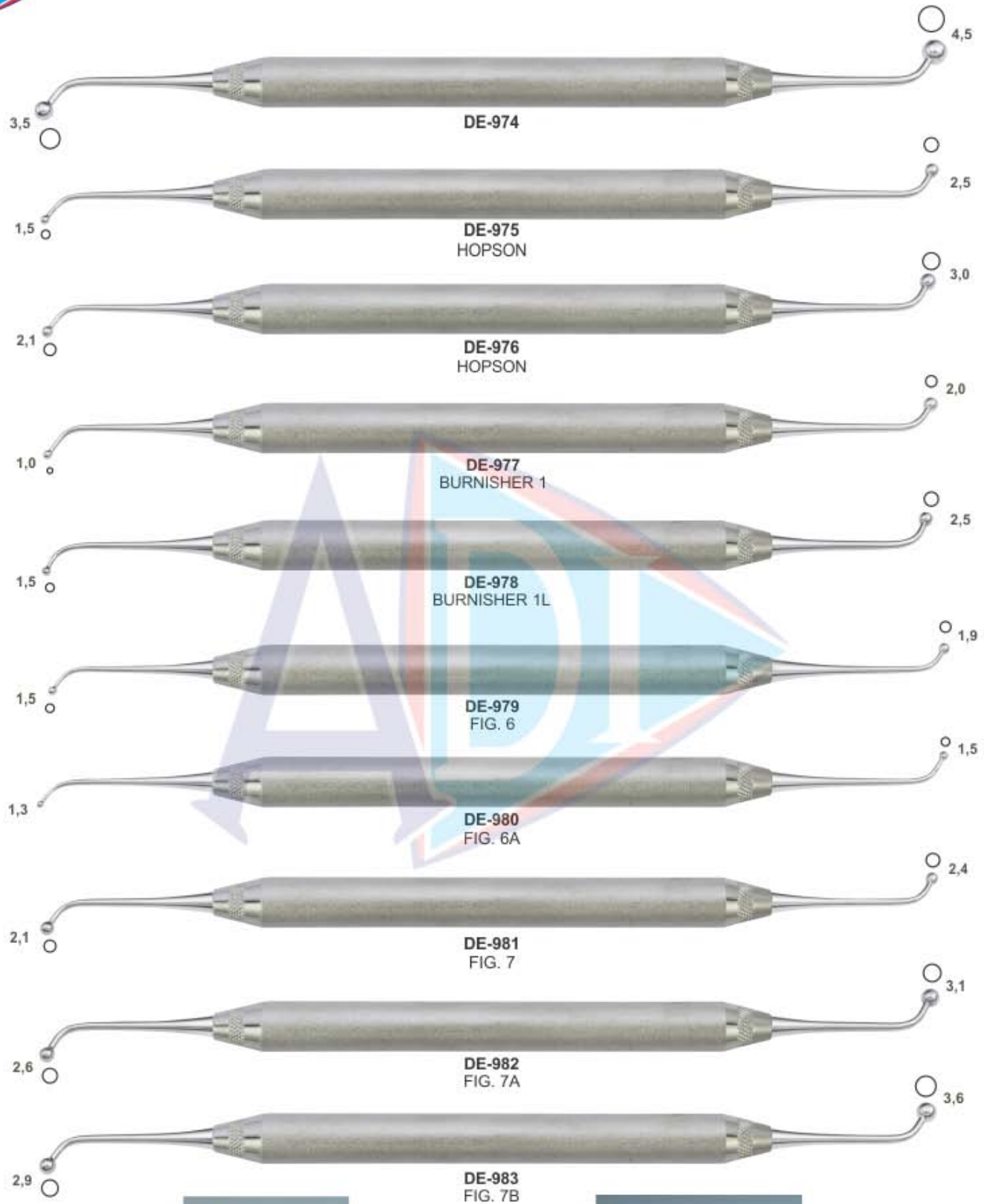

FILLING INSTRUMENTS CONSERVATIVE TREATMENT



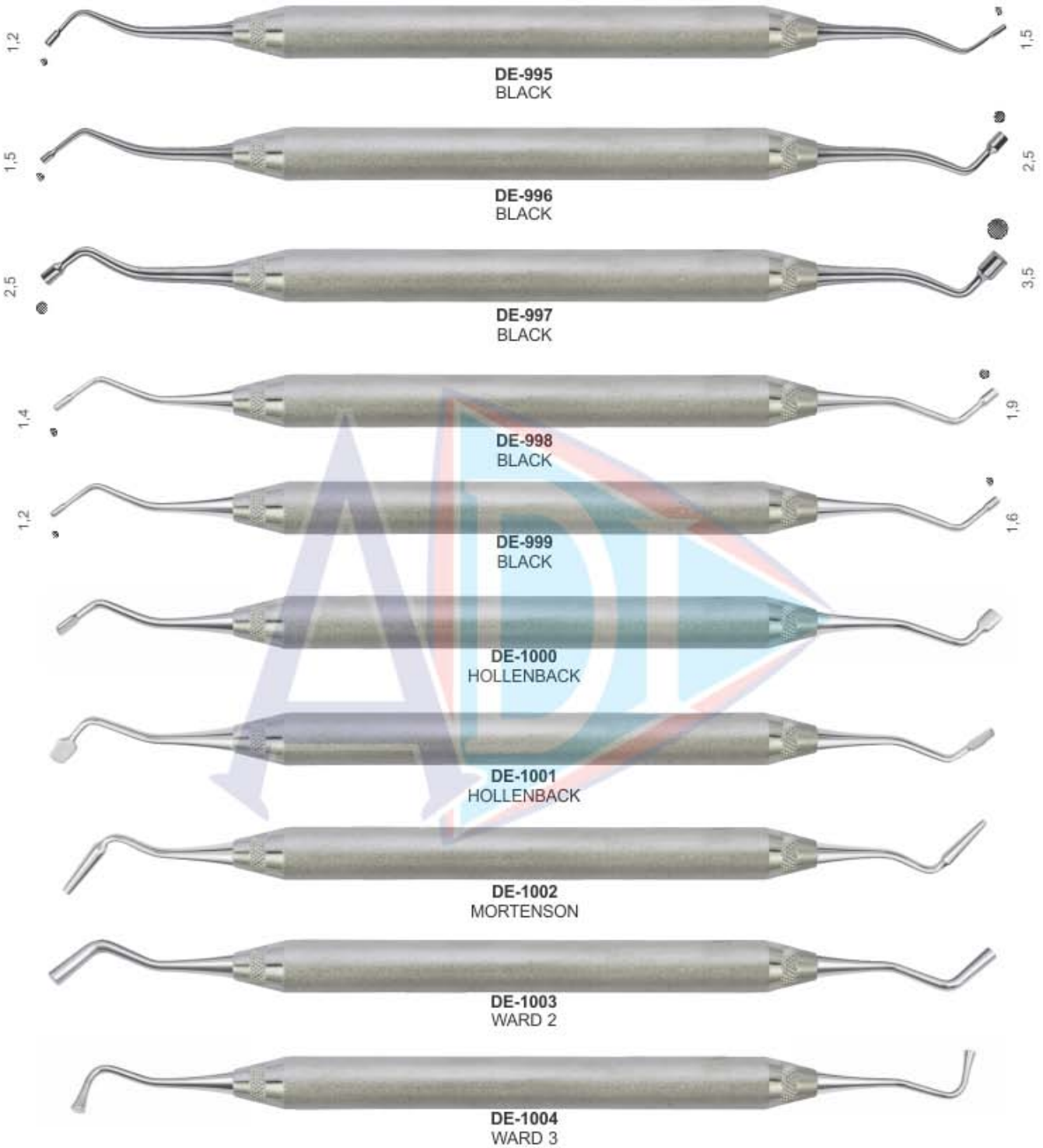



DE-1005
WILLIAMS



DE-1006
WILLIAMS



DE-1007
WILLIAMS



DE-1008



DE-1009



DE-1010



DE-1011



DE-1012



DE-1013



DE-1014



COMPOSITE PLUGGERS INSTRUMENTS



COMPOSITE PLUGGERS INSTRUMENTS

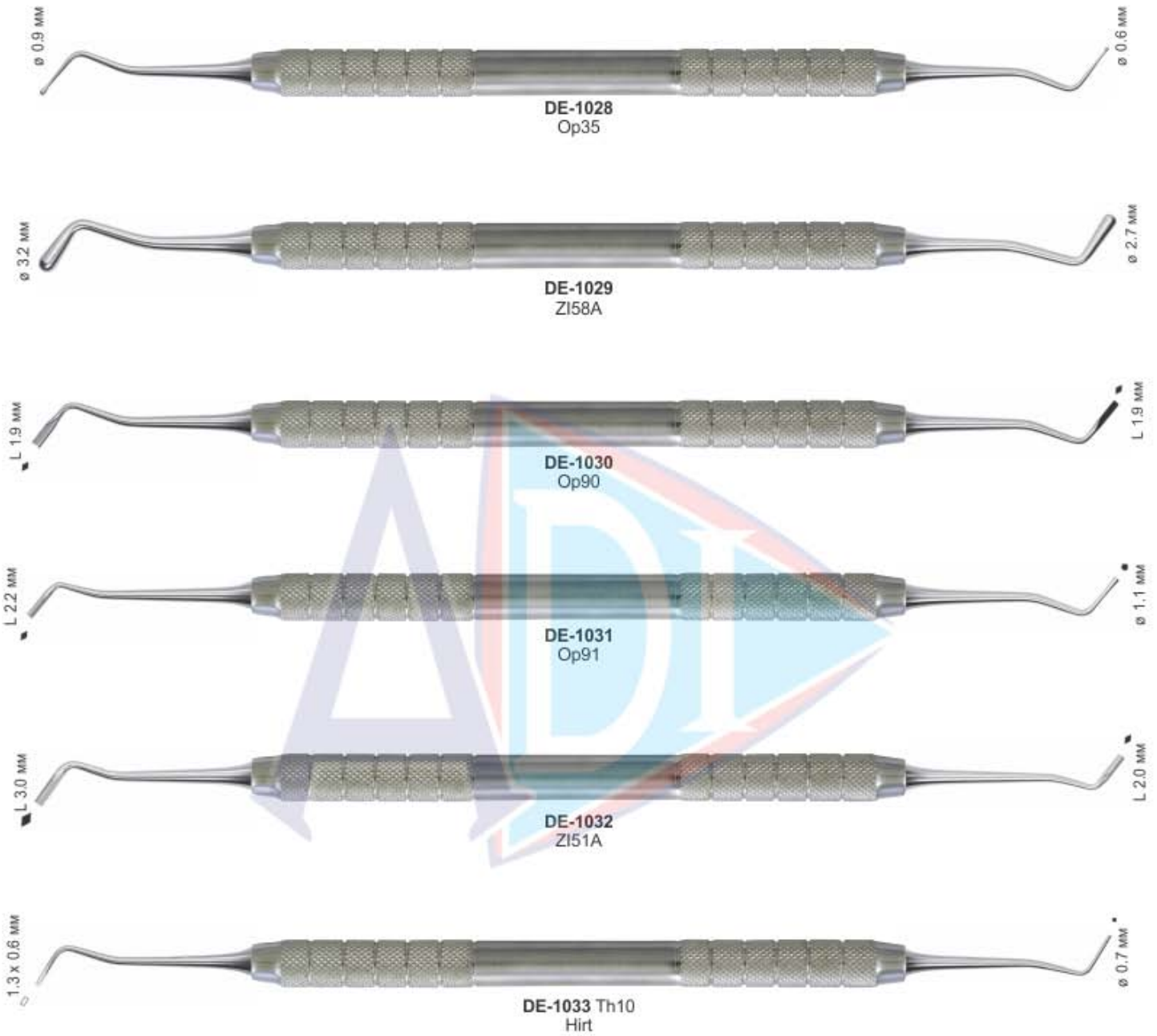



FILLING INSTRUMENTS CONSERVATIVE TREATMENT

Serrated Pluggers



Model	Tip Diameter (mm)
DE-1034 OP36M	Ø 1.2
DE-1035 OP36D	Ø 1.6
DE-1036 Op36	Ø 2.2
DE-1037 Op52	Ø 1.7
DE-1038 Zi51	Ø 2.6
DE-1039 Op44	Ø 2.2
DE-1040 1BR2	Ø 2.6
DE-1041 2BR3	Ø 3.6





DE-1042 MF2C
Fuzzi



DE-1043
Pj4



DE-1044 MB3C
Besek



DE-1045
HZ3C



DE-1046
CPRO3C



DE-1047 Mo1
Monari



DE-1048 TH28C
Hirt



DE-1049
HZ25C



DE-1050
Ck10



DE-1051
CK28BC



DE-1052 Op37
Carver



DE-1053
28BR29

Round excavators

- Cariology**
- for the removal of softened, carious dentin
 - for the removal of temporary fillings
- Surgery**
- to sever the periodontal ligament prior to extraction
 - for the removal of granulation tissue after extraction
- Design: Round working end Curved cutting edge



Round Excavator, 1.0 mm
DE-1054



Round Excavator, 1.5 mm
DE-1055



Round Excavator, 2.0 mm
DE-1056

Triple-angled back action excavators



Triple-angled Back Action Excavator, 1.0 mm
DE-1057



Triple-angled Back Action Excavator, 1.5 mm
DE-1058



Triple-angled Back Action Excavator, 2.0 mm
DE-1059



Triple-angled Back Action Excavator, 3.5 mm
DE-1060



FILLING INSTRUMENTS



- Инструменты для реставрации
- Instruments pour plombage
- Füllungsinstrumente (mit Kontrawinkel)
- Инструменти для реставрації
- Instrumentos para obturaciones
- ملء الصكوك

COMPOSITE/PLASTIC FILLING INSTRUMENTS SOLID HANDLE 6MM, LENGTH 170MM

BLACK

PLUGGERS/CONDENSERS

Hollenback

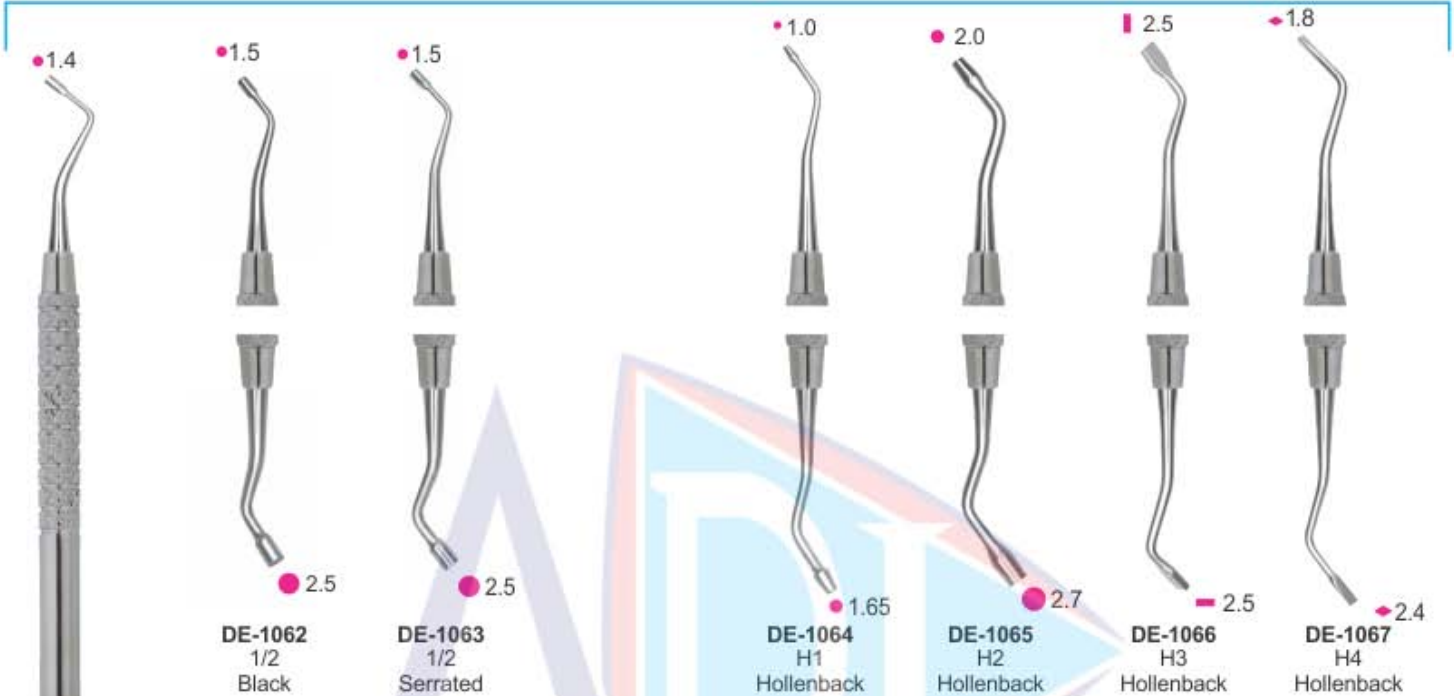

MARQUETTE CONDENSER

MORTONSON

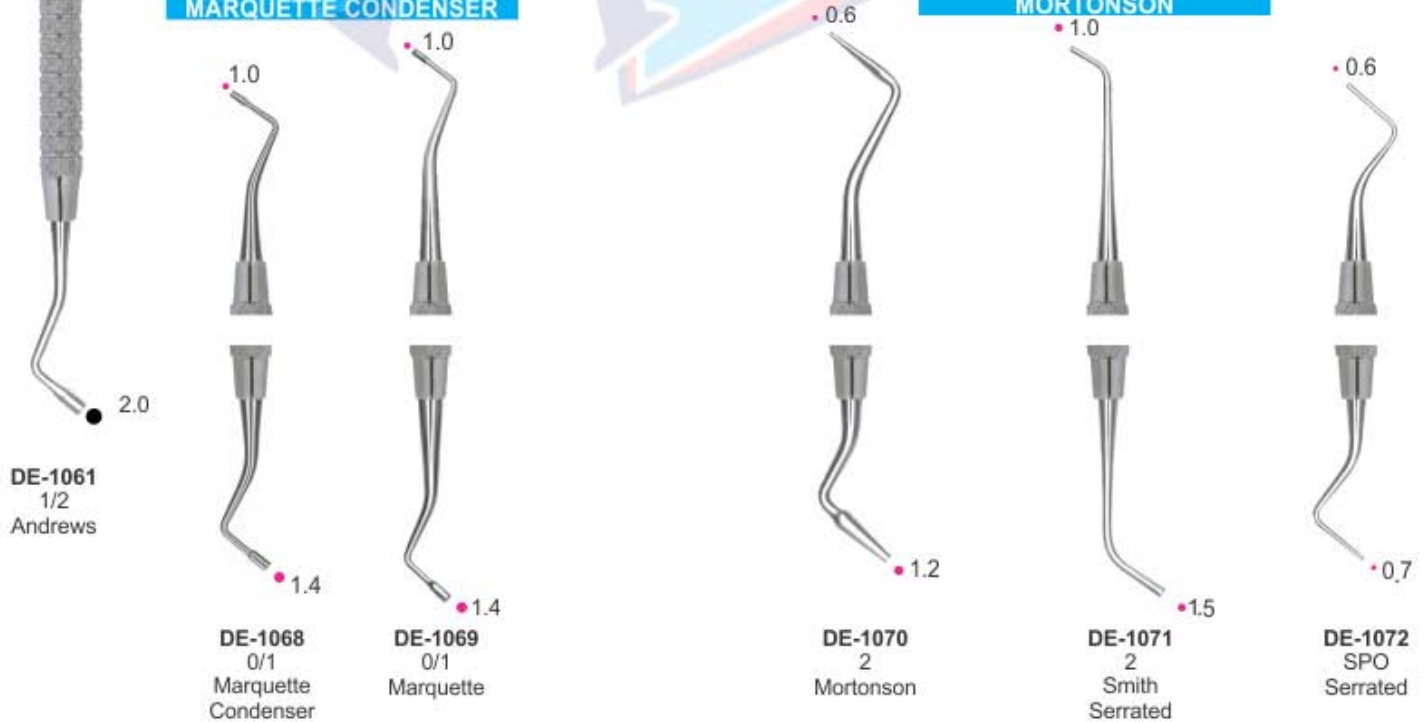



FILLING INSTRUMENTS

- Инструменты для реставрации
- Instruments pour plombage
- Füllungsinstrumente (mit Kontrawinkel)
- Инструменти для реставрації
- Instrumentos para obturaciones
- ملء الصكوك

RESTORATIVE INSTRUMENTS SOLID HANDLE 6MM, LENGTH 170MM Back Action Filling Instruments

Tanner Filling Instruments



DE-1074
2T
Tanner

DE-1075
3T
Tanner

DE-1076
9/10
Back Action

DE-1077
11/12
Back Action

DE-1078
153
English Pattern
Serrated

DE-1079
153
English Pattern
Serrated

BALL

BURNISHERS

BEAVERTAIL

ACORN

LADMORE

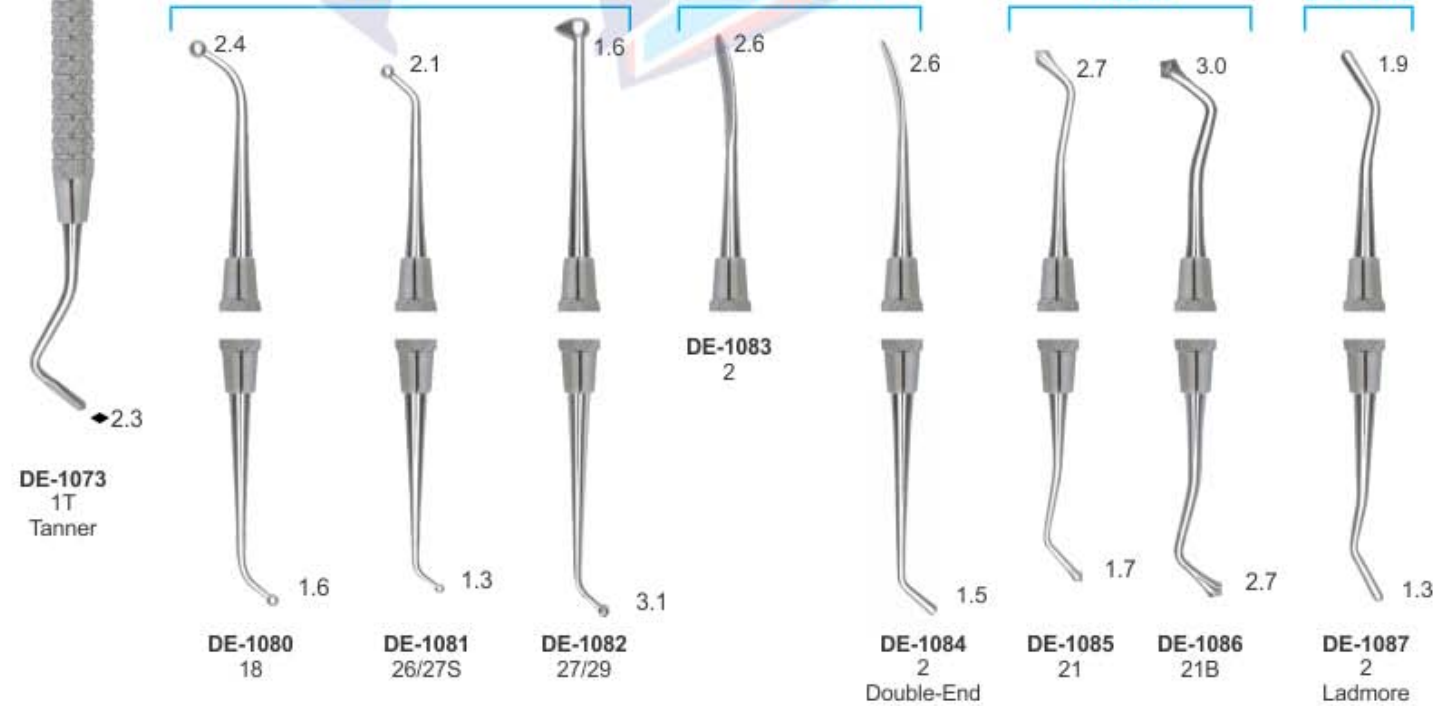

DE-1073
1T
Tanner

DE-1080
18

DE-1081
26/27S

DE-1082
27/29

DE-1083
2

DE-1084
2
Double-End

DE-1085
21

DE-1086
21B

DE-1087
2
Ladmore

CARVERS INSTRUMENTS



- Инструменты для реставрации
- Instruments a modeler
- Modellierinstrumente
- Инструменти для реставрації
- Instrumentos para modelar
- أدوات تطعيم

P.K. THOMS WAXING INSTRUMENTS SOLID HANDLE 6mm



DE-1095
Composite Instruments Blue
Titanium with Cassettes



DE-1094
P.k. Thomas Waxing Instruments Kit

COMPOSITE INSTRUMENTS TITANIUM BLUE ENDODONTIC

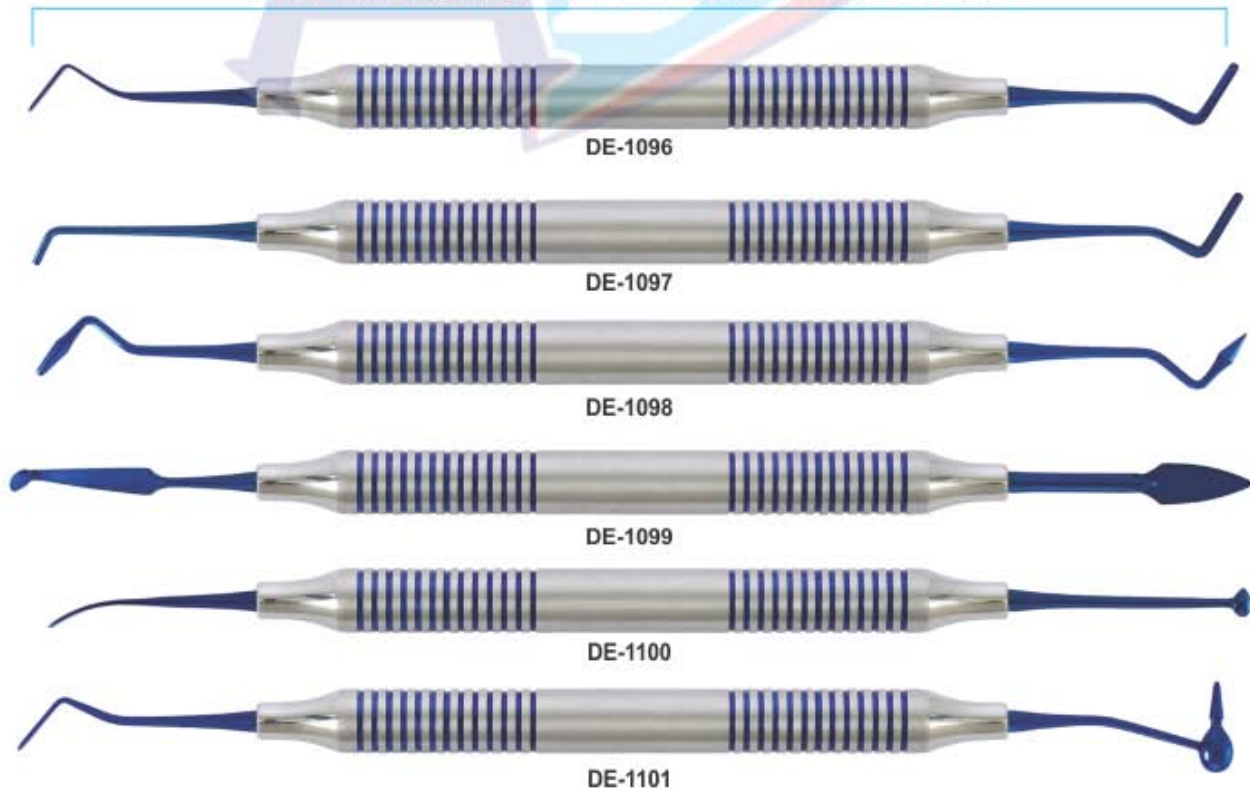



CARVERS INSTRUMENTS

- Инструменты для реставрации
- Instruments a modeler
- Modellierinstrumente
- Инструменти для реставрації
- Instrumentos para modelar
- أدوات تقطيع



DE-1102



DE-1103



DE-1104



DE-1105



DE-1106



Cassette For 5 Instruments
DE-1107

FILLING INSTRUMENTS



- Инструменты для реставрации
- Instruments pour plombage
- Füllungsinstrumente (mit Kontrawinkel)
- Инструменти для реставрації
- Instrumentos para obturaciones
- ملء الصكوك

FILLING INSTRUMENTS (Gold Pointed) SOLID HANDLE 6MM, LENGTH 170MM



DE-1108 1.5mm / 1.5mm

DE-1109 2.0mm / 2.0mm

DE-1110 2.0mm / 2.0mm

DE-1111 2.5mm / 2.5mm

DE-1112 1.3mm / 0.9mm

DE-1113 1.6mm / 1.3mm

DE-1114 2.4mm / 1.8mm

DE-1115 2.4mm / 2.0mm

DE-1116 1.3mm / 1.5mm

DE-1117 1.8mm / 1.2mm

Filling instrument, spatula 6 mm solid handle, length 170 mm,

Filling instrument 6 mm length 175 mm,

Filling instrument, ball 6 mm length 170 mm,

Filling instrument, ball / spatula 6 mm length 175 mm,

Filling instrument, plan / plan 6 mm length 165 mm,



COMPOSITE FILLING INSTRUMENTS

- Инструменты для реставрации
- Instruments pour plombage
- Füllungsinstrumente (mit Kontrawinkel)
- Інструменти для реставрації
- Instrumentos para obturaciones
- ملء الصكوك

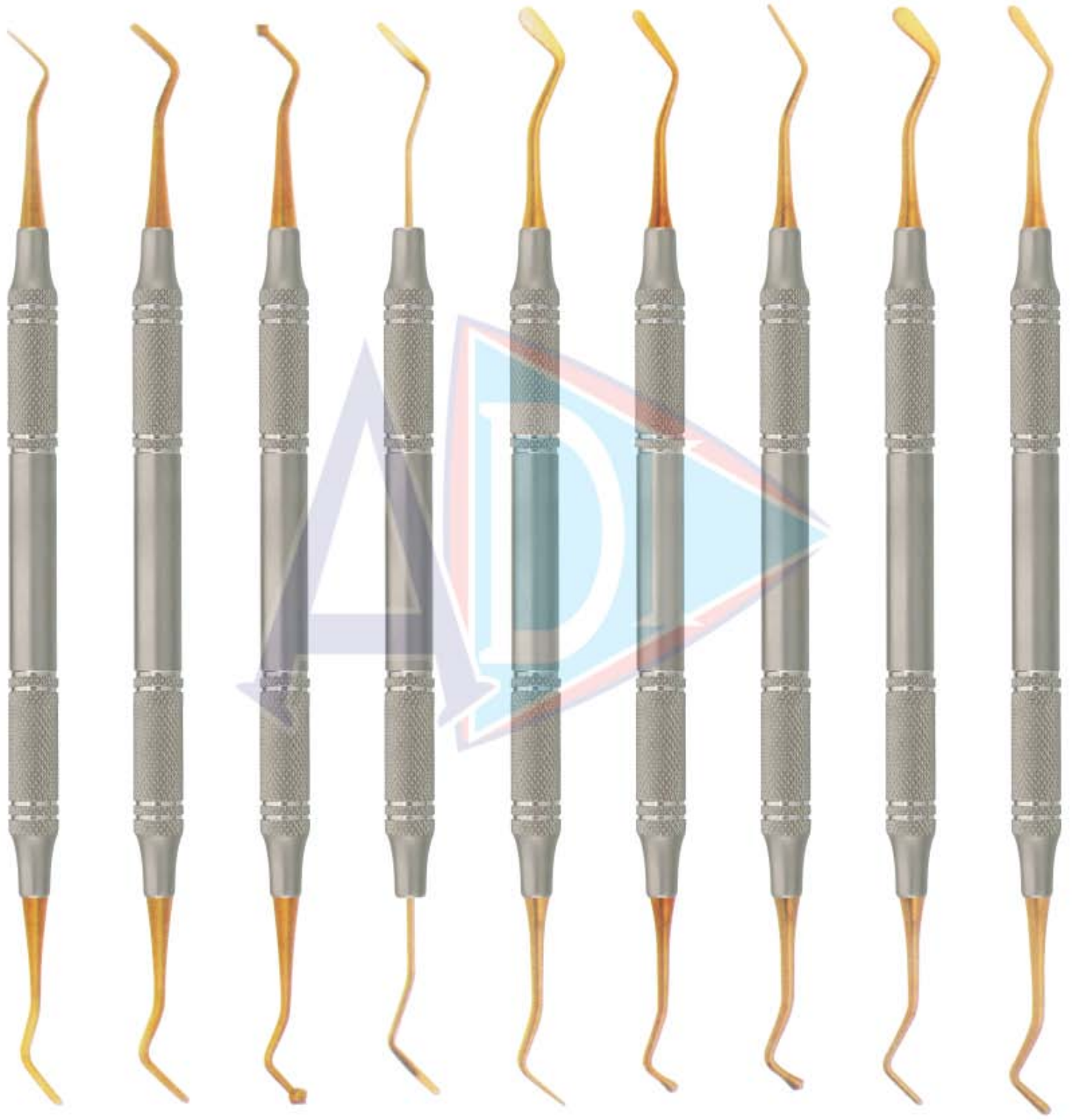

DE-1118

DE-1119

DE-1120

DE-1121

DE-1122

DE-1123

DE-1124

DE-1125

DE-1126

COMPOSITE FILLING INSTRUMENTS



- Инструменты для реставрации
- Instruments pour plombage
- Füllungsinstrumente (mit Kontrawinkel)

- Инструменти для реставрації
- Instrumentos para obturaciones
- ملء الصكوك

Composite Gold Tip Instruments





MISCELLANEOUS PRODUCTS

- Прочие товары
- Divers produits et services
- Sonstige Produkte
- Інші товари
- Varios Productos
- المنتجات المتنوعة



DE-1138
X Ray Film Hangers



DE-1139
X Ray Film Hangers



DE-1140
X Ray Film Hangers



DE-1141
X Ray Film Hangers



DE-1142
X Ray Film Hangers



DE-1143
X Ray Film Hangers



DE-1144
X Ray Film Hangers



DE-1145



DE-1146



DE-1147



Dissecting Set
DE-1148 Set of 9 Pcs.
DE-1149 Set of 11 Pcs.



DE-1150
Napkin Holder with
Plastic Chain

DE-1151
Napkin holder with metal chain



Mouth Props
DE-1152
Small

Mouth Props
DE-1153
Medium

Mouth Props
DE-1154
Large

Key Rings



DE-1155



DE-1156



DE-1157



DE-1158



DE-1159



DE-1160

CEMENT SPATULAS



- Шпатели для цемента
- Spatules à ciment
- Zementspatel
- Шпателі для цементу
- Espátulas para cemento
- ملاعق الإسمنت





WAX KNIVES

- Ножи для воска
- Couteaux a cire
- Wachsmesser
- Ножи для воску
- Cuchillos para cera
- المسكين الشمع

ALGINATE, PLASTER SPATULAS, WAX KNIVES PLASTER FOR KNIVES & PLASTER SHEAR



DE-1183
Wooden Handle
Fig. 5
21.5 cm



DE-1184
Wooden Handle
Fig. 7
19.5 cm curved



DE-1185
Wooden Handle
Fig. 8
20 cm curved



DE-1186
Wooden Handle
Fig. 9
22.5 cm curved



DE-1187
Hook Knives



DE-1188
Fig. 1
Lessmann
12.5 cm



DE-1189
Fig. 2
Lessmann
17 cm



DE-1190
Fig. 1
with small spoon
12.5 cm



DE-1191
Fig. 2
with large spoon
17 cm



DE-1192
Bacolite Handle
Wax Knives,
Small



DE-1193
Bacolite Handle
Wax Knives,
Large



DE-1194
Wooden Handle
Wax Knives,
Small



DE-1195
Wooden Handle
Wax Knives,
Large



DE-1196
Plaster Knife



DE-1197
Fig. 1
17 cm



DE-1198
Fig. 3
16 cm



DE-1199
Fig. 4
16 cm



DE-1200
Special Inox
19.5 cm

ARTICULATORS



- Артикуляторы
- Artocilar
- Artikulations

- Артикулятори
- Articuler
- ارتیکو لاتورس



DE-1201

Technical Datas:

Intercondylar distance 120 mm.
 condylar inclination fixed at 30°
 Bennet angle fixed at 7°
 Incisal table inclination 10°
 Distance between mounting plates 85 mm.
 Weight 400 gr.
 Opening (item 5000) 125°
 Opening (item 5010) 180°



DE-1202

Technical Datas:

Intercondylar distance 110 mm.
 condylar inclination fixed at 30°
 Bennet angle fixed at 7°
 Incisal table inclination flat
 Distance between mounting plates 85 mm.
 Weight 450 gr.
 Opening 180°



DE-1203

Stainless Steel Finishing

DE-1204

Royal Blue



DE-1205



DE-1206



DE-1207



DE-1208



DE-1209



DE-1210



DE-1211



DE-1212



DE-1213



DE-1214
 Nakawalni
 Dental Laboratory
 Instrument



DENTAL PHOTOGRAPHIC MIRRORS

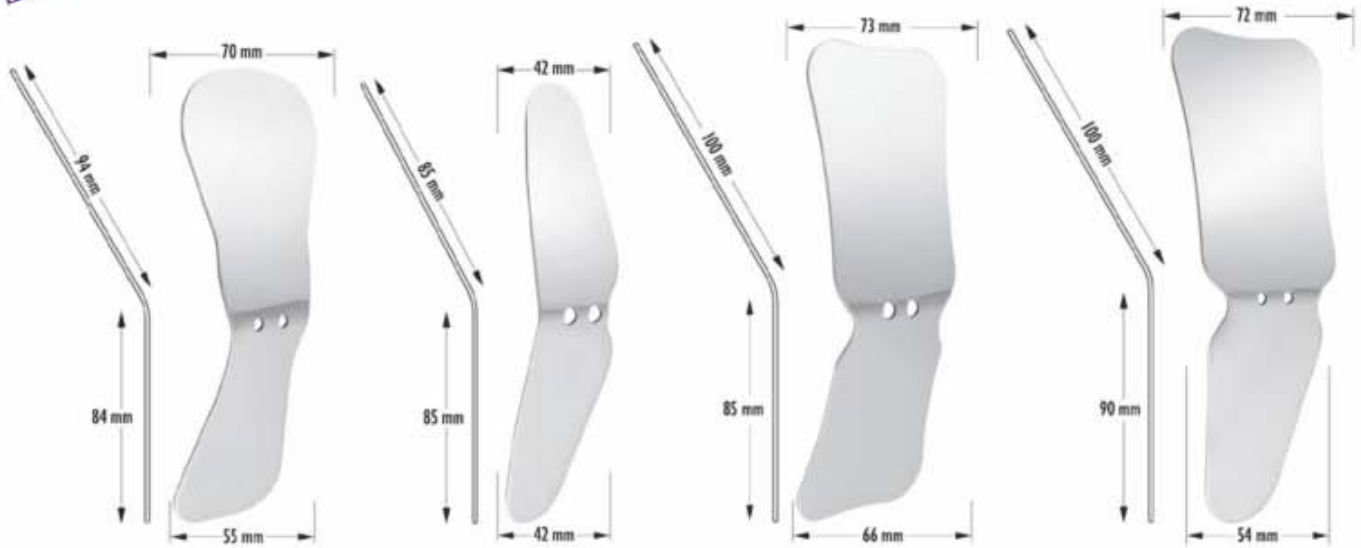

DE-1215 Adult Palatal /
DE-1216 Child Palatal

DE-1217
Buccal

DE-1218 Adult Palatal /
DE-1219 Child Palatal

DE-1220 Adult Palatal /
DE-1221 Adult Buccal

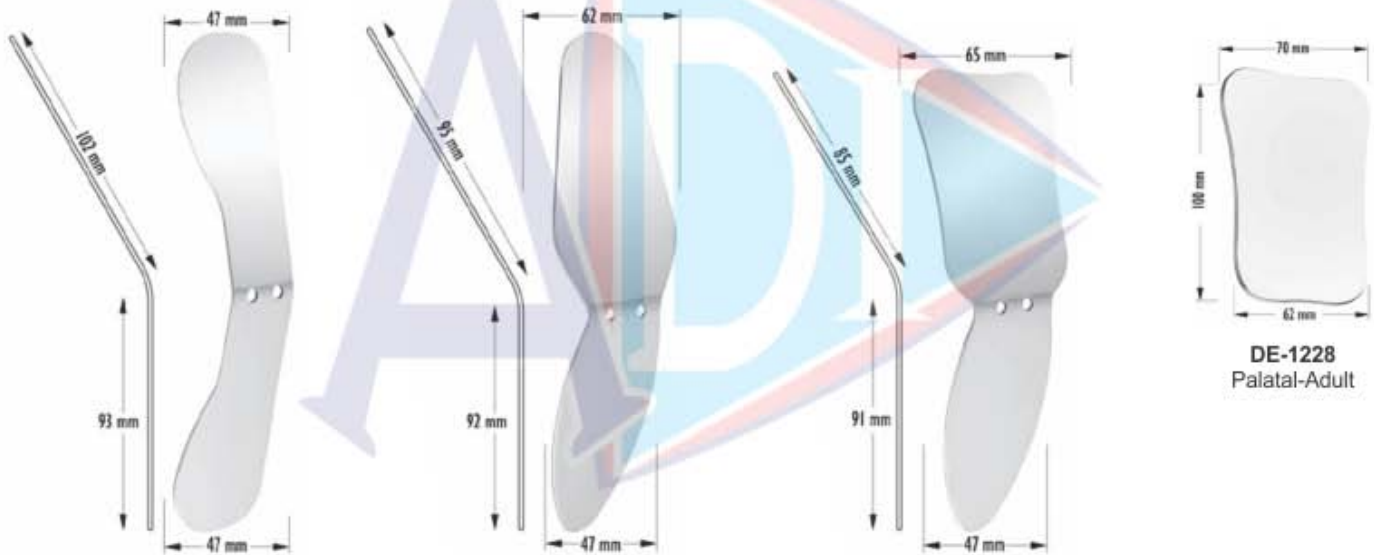

DE-1222 Lingual upper /
DE-1223 Lingual Lower

DE-1224 Adult Buccal /
DE-1225 Child Buccal

DE-1226 Child Palatal /
DE-1227 Child Buccal

DE-1228
Palatal-Adult

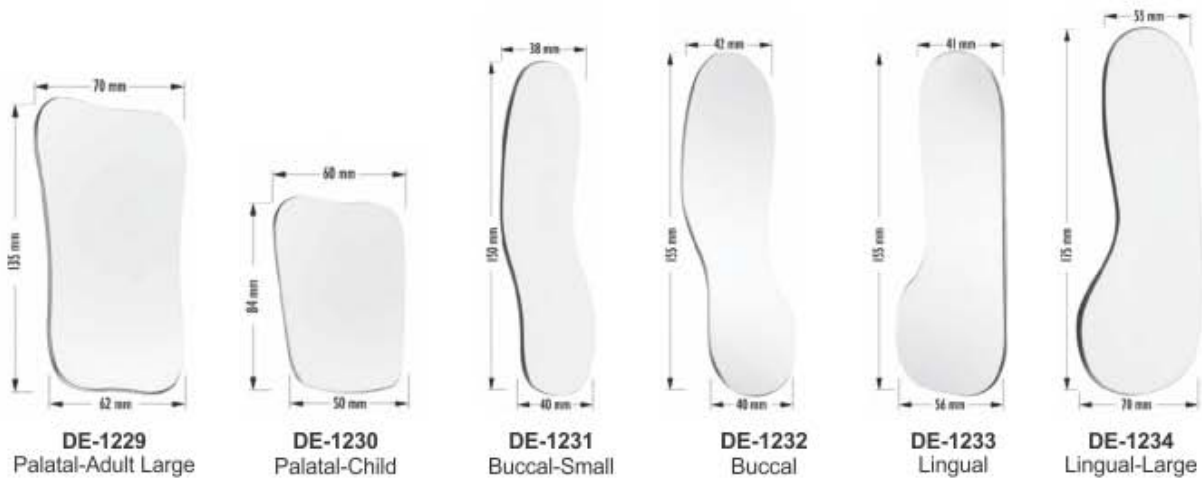

DE-1229
Palatal-Adult Large

DE-1230
Palatal-Child

DE-1231
Buccal-Small

DE-1232
Buccal

DE-1233
Lingual

DE-1234
Lingual-Large

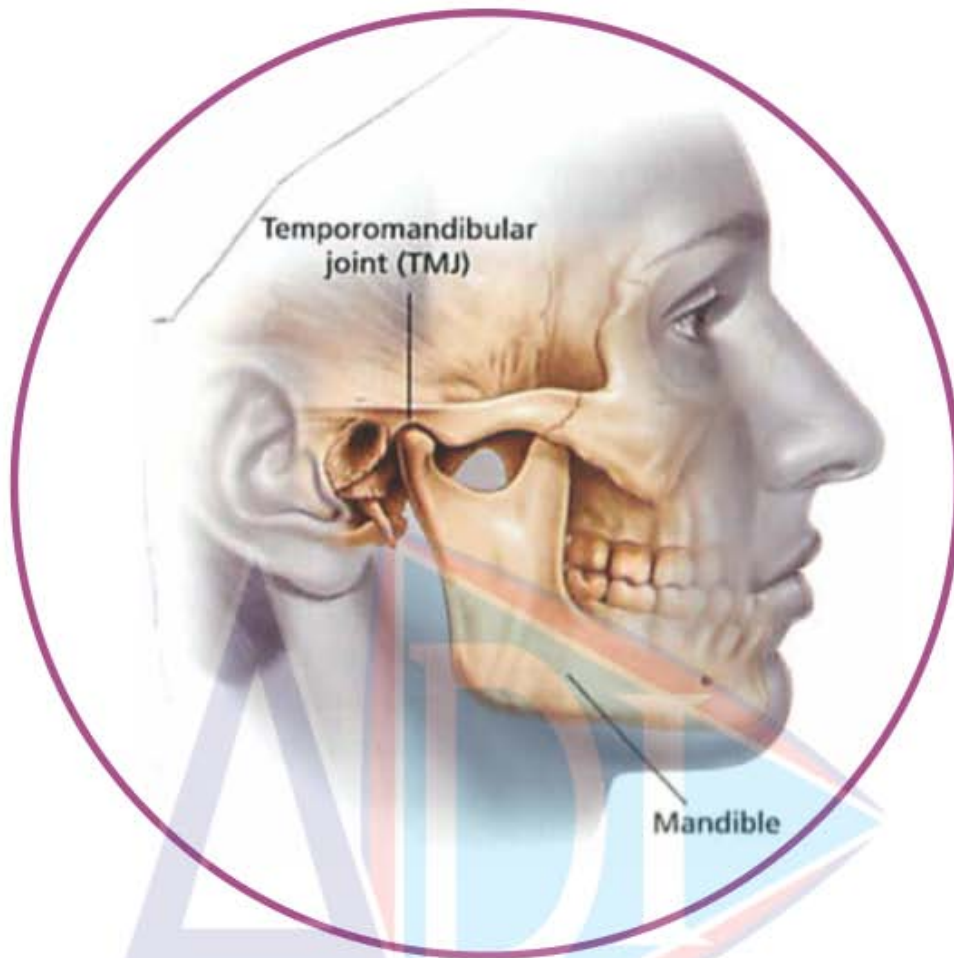

RETRACTORS - MOUTH GAGS

- Роторасширители
- Ecarteurs - Ouvre-bouches
- Vestibulumabhalter / Mundspanner
- Роторозширювачі
- Separadores - Abre-bocas
- الكاشطات - الكمامات الفم



DE-1251
HMG
Heister
130mm



DE-1252
Mouth Gag Molt
11 cm for (Children)



DE-1253
Mouth Gag Molt
14 cm for (Adults)



Sternberg Retractors
DE-1254 140 mm
DE-1255 180 mm



Columbia Retractor
DE-1256 140 mm



DE-1257
Wangen Holder
vestibule
15 cm, with or without
lip protection,



DE-1258
Wangen Holder
vestibule 15 cm, with
or without lip protection



DE-1259
Wangen Holder
with dual
function, 17 cm

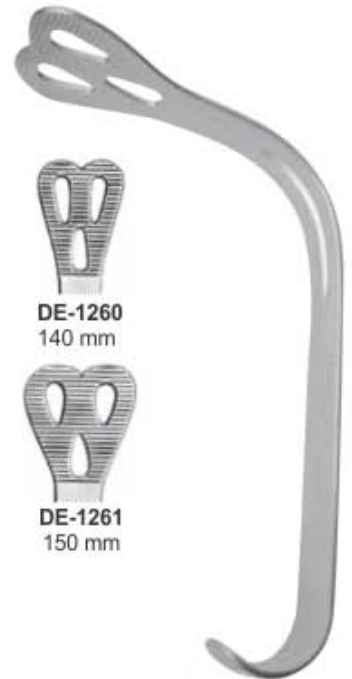

Weider Retractor



DE-1260
140 mm



DE-1261
150 mm

RETRACTORS - MOUTH GAGS



- Роторасширители
- Ecarteurs - Ouvre-bouches
- Vestibulumabhalter / Mundspanner
- Роторозширювачі
- Separadores - Abre-bocas
- الكاشطات-الكمامات الفم



Weitlaner
Fig. 1
DE-1262 10.5cm
DE-1263 13.5cm



Weitlaner
Fig. 2
DE-1264 10.5cm
DE-1265 13.5cm



DE-1266
Lip & Cheek Retractor
Stainless Steel
Double Ended



DE-1267
Simplex Retractor
Stainless Steel
Single Ended



Weitlander
DE-1268 11cm
DE-1269 13cm
DE-1270 15cm



DE-1274
Denhard
12 cm



DE-1275
Roser-König
16 cm



DE-1276
Roser-König
19 cm



Jennings
DE-1271 11cm
DE-1272 13cm
DE-1273 15cm

RETRACTORS

- Ранорасширители
- Ecarteurs
- Wundhaken
- Ранорозширювачі
- Separadores
- الكاشحات

Wound, Bendable
Retractor, individually or as saving kit!



DE-1277
Cheek Retainer
One-sided
Long



DE-1278
Cheek Retainer
One-sided
Long



DE-1279
Cheek Retainer
One-sided
Long



**Ergo Grip
Retractor**
DE-1280 24 cm
ergonomic handle,



Ivory Retractors
Width adjustable
& fixable,
DE-1281 20 cm



Bruenings Retractors
tongue depressors
DE-1282 19 cm



**Minnesota
Retractors**
DE-1283 16 cm



Ribbon Retractors
DE-1284 20 cm
easy to bend
by hand,



Bishop Retractors
retractor and tongue
pushers Bishop with
comfortable margin
DE-1285 16 cm



**Combination
Retractors**
DE-1286 25 cm

RETRACTORS



- Ранорасширители
- Ecarteurs
- Wundhaken
- Ранорозширювачі
- Separadores
- الكاشحات



DE-1287
Unique Retractors
Length 175 mm
angled 45 °



DE-1288
Unique Retractors
Length 175 mm
angled 90°



DE-1289
Retractors
16cm



DE-1290
Retractors
19cm



DE-1291
Mini-Langenbeck
Retractors
16 cm, hooks 22 mm



DE-1292
US army Retractors
21 cm, 2



DE-1293
ALM Retractor
about 8 cm



DE-1294
Senn Mueller Retractor
17 cm, hooks 22 mm

RETRACTORS

- Ранорасширители
- Ecarteurs
- Wundhaken
- Ранорозширювачі
- Separadores
- الكاشحات



DE-1295
Langenbeck Retractors
surgical-flat
21 cm, hook
30x16 mm



DE-1296
Langenbeck Retractors
surgical-flat
21 cm, hook
42x11 mm



DE-1297
Langenbeck Retractors
surgical-flat
21 cm, hook
63x12 mm



Langenbeck Retractors
surgical-flat
21 cm, hook
DE-1298 30x16 mm
DE-1299 42x11 mm
DE-1300 63x12 mm



Langenbeck Retractors
21 cm, hook
DE-1301 30x11 mm
DE-1302 30x16 mm



DE-1303
Middelborpf
Retractors
21 cm



DE-1304
Farabeuf
(120 X 12mm
Set of 2 pices)



DE-1305
Retractor Seldin



DE-1306
Feldman Retractor
14cm

GUM SCISSORS



- Ножницы десневые
- Ciseaux a gencives
- Zahnfleischscheren

- Ножиці для ясен
- Tijeras para encias
- مقص صمغ



DE-1307
Iris
115mm
Straight



DE-1308
Iris
115mm
Curved



DE-1309
Goldman-Fox
130mm
Saw edge, straight



DE-1310
Goldman-Fox
130mm
Saw edge, Curved



DE-1311
La Grange
115mm
Saw edge, double Curved



Mayo
DE-1312 140mm
DE-1313 170mm
DE-1314 230mm
Straight



Mayo
DE-1315 140mm
DE-1316 170mm
DE-1317 230mm
Curved



Metzenbaum
DE-1318 145mm
DE-1319 180mm
DE-1320 200mm
Straight

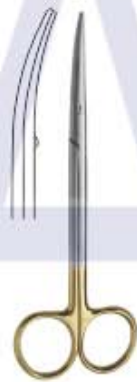

Metzenbaum
DE-1321 145mm
DE-1322 180mm
DE-1323 200mm
Curved



DE-1324
Kelly
160mm
Straight



DE-1325
Kelly
160mm
Curved



DE-1326
Iris
115mm
Straight



DE-1327
Iris
115mm
Curved



DE-1328
La Grange
115mm
Double Curved



DE-1329
Goldman-Fox
130mm, Straight



DE-1330
Goldman-Fox
130mm, Curved



DE-1331
Kelly
160mm, Curved



DE-1332
Iris
115mm, Straight



DE-1333
Iris
115mm, Curved



DE-1334
Micro Iris
90mm, Curved

GUM SCISSORS

- Ножницы десневые
- Ciseaux a gengivas
- Zahnfleissscheren
- Ножиці для ясен
- Tijeras para encias
- مقص صمغ



DE-1335
Iris
115mm
Angled



DE-1336
Iris
115mm
Curved



DE-1337
Goldman-Fox
130mm
Saw edge,
straight



DE-1338
Goldman-Fox
130mm
Saw edge,
curved



DE-1339
Goldman-Fox
130mm
Saw edge,
double curved



DE-1340
La Grange
115mm
Saw edge,
double curved



DE-1341
Neumann
120mm
Saw edge,
double curved



DE-1342
Kilner (Ragnell)
120mm
Straight



DE-1343
Kilner (Ragnell)
120mm
Curved



DE-1344
Joseph
140mm
Straight



DE-1345
Joseph
140mm
Curved



DE-1346
Kelly
160mm
Straight



DE-1347
Kelly
160mm
Curved



DE-1348
Locklin
160mm
Saw edge,
angular



DE-1349
Locklin
120mm



DE-1350
Locklin
160mm
Saw edge,
angular

DE-1351
Dean
170mm
Saw edge,
angular



DE-1352
Spencer
90mm



DE-1353
Spencer
130mm



DE-1354
Spencer
115mm



DE-1355
Noyes
110mm, Straight



DE-1356
Noyes
110mm
Curved



DE-1357
Noyes
110mm
Angular



DE-1358
Castroviejo
150mm
Curved

GUM SCISSORS

NEEDLE HOLDERS

- Ножницы десневые
- Ciseaux a gengivas
- Zahnfleischscheren

- Ножиці для ясен
- Tijeras para encias
- منصص صمغ

- Иглодержатели
- Porte-aiguilles
- Nadelhalter

- Голкотримачі
- Porta-agujas
- اصحاب ابرة



DE-1359
130mm
Straight



Mayo Mayo
130mm 130mm
DE-1360 160mm 160mm
DE-1361 180mm 180mm
DE-1362 Straight Curved



Mayo Mayo
140mm 140mm
DE-1363 200mm 200mm
DE-1364 Straight Curved



Metzenbaum
145mm 145mm
DE-1365 200mm 200mm
DE-1366 Straight Curved



DE-1367
Beebee
110mm
Saw edge,
straight



DE-1368
Beebee
110mm
Saw edge,
curved



DE-1369
Beebe
110mm
Saw edge, straight



DE-1370
Beebe
110mm
Saw edge, curved

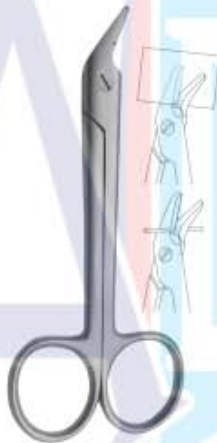

DE-1371
Universal
120mm
Saw edge



DE-1372
Universal
120mm



Ryder
DE-1373 130mm
DE-1374 150mm
DE-1375 180mm



DE-1376
Halsey
130mm



DE-1377
Baumgartner
130mm



DE-1378
Derf
120mm



DE-1379
Delicate
150mm



Mayo-Hegar
DE-1380 130mm
DE-1381 160mm
DE-1382 180mm
DE-1383 200mm



DE-1384
Crile-Wood
150mm
straight



DE-1385
Crile-Wood
150mm
curved

NEEDLE HOLDERS

- Иглодержатели
- Porte-aiguilles
- Nadelhalter
- Голкотримачи
- Porta-agujas
- اصحاب ابرة

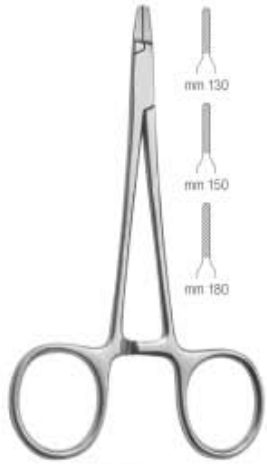

Ryder
DE-1386 130mm
DE-1387 150mm
DE-1388 180mm



DE-1389
Halsey
130mm



DE-1390
Baumgartner
130mm



DE-1391
Derf
120mm



DE-1392
Delicate
150mm



DE-1393
Adson
170mm



Mayo-Hegar
DE-1394 130mm
DE-1395 160mm
DE-1396 180mm
DE-1397 200mm



DE-1398
Crile-Wood
150mm



Castroviejo
DE-1399 str 140mm cvd
DE-1400 str 180mm cvd



Olsen-Hegar Needle
Holder With Scissors
DE-1401 140mm



Gillies Needle
Holder With Scissors
DE-1402 160mm



Mathieu
DE-1403 140mm
DE-1404 170mm



Castroviejo
DE-1405 str 140mm cvd
DE-1406 str 180mm cvd



Olsen-Hegar Needle
Holder With Scissors
DE-1407 140mm



Gillies Needle
Holder With Scissors
DE-1408 160mm

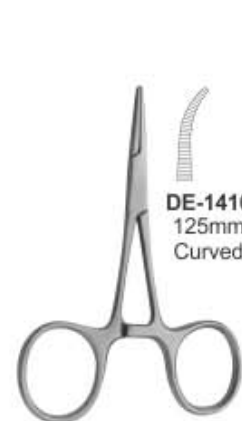

Hartmann (Baby
Mosquito)
DE-1409 90mm straight



Halstead Mosquito
DE-1411 125mm
Straight

DE-1410
125mm
Curved

DE-1412
Curved

GUM SCISSORS



- Ножницы десневые
- Ciseaux a gencives
- Zahnfleischscheren
- Ножиці для ясен
- Tijeras para encias
- مقص صمغ



DE-1413
Goldman Fox Scissors
12.5cm Curved



DE-1414
Iris Scissors
11.5cm Curved
Serrated For Slip-Free Cutting



DE-1415
LaGrange Scissors
11.5cm Double Curved
Serrated For Slip-Free Cutting

Double
Curved



DE-1416
Castroviejo Micro Scissors
12cm Curved



DE-1417
Super Cut Goldman Fox
13.2cm Curved
Serrated For Slip-Free Cutting



DE-1418
Super Cut Iris
11cm Straight
Serrated For Slip-Free Cutting



DE-1419
Super Cut LaGrange
11cm Curved
Serrated For Slip-Free Cutting



DE-1420
Super Cut LaGrange
11.5cm
Double Curved
Serrated For Slip-Free Cutting

Double
Curved

NEEDLE HOLDERS

- Иглодержатели
- Porte-aiguilles
- Nadelhalter

- Голкотримачи
- Porta-agujas
- اصحاب ابرة



DE-1421
Lichtenberg-
Ryder T.C
14 cm



DE-1422
Lichtenberg-
Ryder T.C
14 cm



DE-1423
Lichtenberg-
Ryder T.C
17 cm



DE-1424
Lichtenberg-
Ryder T.C
17 cm



DE-1425
Barraquer
18 cm



DE-1426
Barraquer
18 cm



DE-1427
Barraquer T.C
18 cm



DE-1428
Barraquer T.C
18 cm



DE-1429
Tönnis
18 cm



DE-1430
Castroviejo
13 cm
Straight



DE-1431
Kalt Needle Holders T.C
14 cm Straight



DE-1432
Peet Splinter Forceps
11.5 cm

DE-1433
La Grange
Curved



DE-1434
All-Purpose Pliers

HAEMOSTATIC FORCEPS & TOWEL CLAMPS



- Зажимы артериальные, зажимы для салфеток
- Pincas hemostatiques, Pincas a compresas
- Arterienklemmen, Tuychklemmen
- Затискачі артеріальні, затискачі для серветок
- Pinzas hemostaticas, Pincas para compresas
- الملقط هيموستاتيک المشابك منشفة

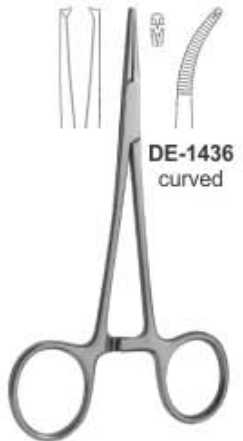

Halstead Mosquito 1x2
DE-1435 125mm
straight

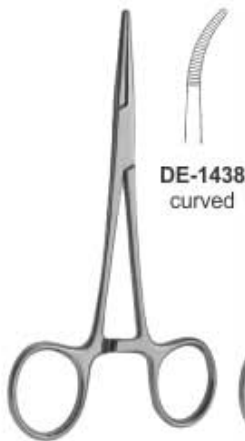

Kelly
DE-1437 140mm
straight

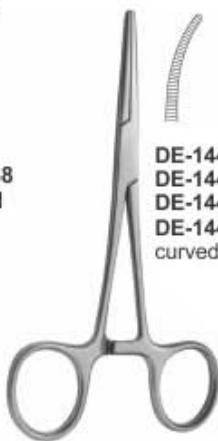

Rochester-Pean
DE-1439 140mm
DE-1440 160mm
DE-1441 180mm
DE-1442 200mm
straight



Rochester-Kocher 1x2
DE-1447 140mm
DE-1448 160mm
DE-1449 180mm
DE-1450 200mm
straight



DE-1455
Kelly-Rankin
160mm
straight

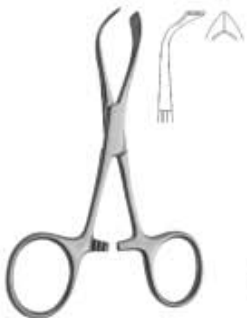

Lorna
DE-1457 100mm
DE-1458 130mm



DE-1459
Allis-Baby 3:4
150mm



DE-1460
Allis 4:5
200mm



DE-1461
Allis 6:7
200mm



Ball Socket
DE-1462 140mm
Not-perforating and
not-damaging



DE-1463
Backhaus
130mm



DE-1464
Backhaus
85mm



DE-1465
Jones
90mm

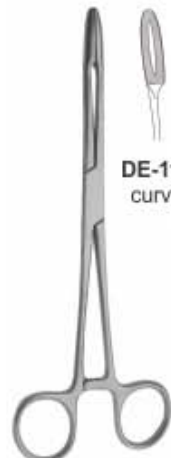

Gross Maier
Dressing Forceps
DE-1466 200mm straight



Foerster
Dressing Forceps
DE-1467 200mm



Young
Tongue Forceps
DE-1468 170mm



Collins
Tongue Forceps
DE-1469 170mm

RUBBER DAM CLAMPS FORCEPS

- Инструменты для системы коффердам
- Pincas porte-crampons a digue
- Kofferdam Klammerzangen
- Инструменти для системи коффердам
- Pinzas de engrapar para dique de caucho
- السد العطاء المنطق المشابك



DE-1470

On request the Content of the rubber dam kit can be changed with other instruments.

Content:

- 01 Anisworth
- 02 Brewer
- 03 Clamps Stand
- 04 Denture Plate
- 05 Rubber Dam Frame
- 06 Rubber Dam Box Lower Case
- 07 Rubber Dam Box Upper Case
- 08 Rubber Dam Clamp Fig. 212
- 09 Rubber Dam Clamp Fig. 211
- 10 Rubber Dam Clamp Fig. 8
- 11 Rubber Dam Clamp Fig. 8A
- 12 Rubber Dam Clamp Fig. 14
- 13 Rubber Dam Clamp Fig. 14A
- 14 Rubber Dam Clamp Fig. 0
- 15 Rubber Dam Clamp Fig. 00
- 16 Rubber Dam Clamp Fig. 2
- 17 Rubber Dam Clamp Fig. 2A
- 18 Rubber Dam Clamp Fig. 7

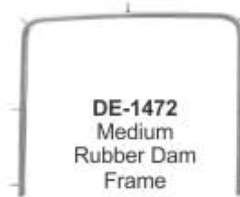
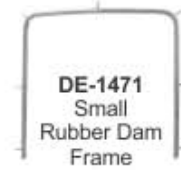

DE-1474
Brewer



DE-1475
Stockes



DE-1476
Palmer



DE-1477
Ivory light weight



DE-1478
Anisworth



DE-1479
Anisworth

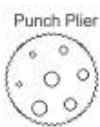

DE-1480
Anisworth



DE-1481
Ivory



DE-1482
Separating
Elastic Plier

RUBBER DAM CLAMPS KITS



- Резиновая дамба зажимы комплекты
- Trousses de caoutchouc
- Gummidammklammern
- Гумова дамба затискачі комплекти
- Conjuntos de abrazaderas de retención de caucho
- المطاط المد المشبك مجموعات



DE-1483

Stainless Steel Gold Plated Rubber Dam Clamp Tray with 11 Different Clamps
Fig. 212, 211, 8, 8A, 14, 14A, 0, 00, 2, 2A, 7



DE-1484

Stainless Steel Rubber Dam Clamp Tray with 12 Different Clamps
Fig. 209, 212, 211, 8, 8A, 14, 14A, 0, 00, 2, 2A, 7



DE-1485

Stainless Steel Rubber Dam Clamp Tray with 8 Different Clamps
Fig. 1, 26, 29, 51, 60, 202, 205, 210



DE-1486

Stainless Steel Rubber Dam Clamp Tray
(without clamps)



DE-1487

On request the Content of the rubber dam kit can be changed with other instruments.

Content:

- | | |
|------------------------------|------------------------------|
| 01 Ivory | 08 Rubber Dam Clamp Fig. 209 |
| 02 Ivory light weight | 09 Rubber Dam Clamp Fig. 212 |
| 03 Clamps Stand | 10 Rubber Dam Clamp Fig. 211 |
| 04 Rubber Dam Frame M | 11 Rubber Dam Clamp Fig. 8 |
| 05 Rubber Dam Frame L | 12 Rubber Dam Clamp Fig. 8A |
| 06 Rubber Dam Box Lower Case | 13 Rubber Dam Clamp Fig. 14 |
| 07 Rubber Dam Box Upper Case | 14 Rubber Dam Clamp Fig. 14A |
| | 15 Rubber Dam Clamp Fig. 0 |
| | 16 Rubber Dam Clamp Fig. 00 |
| | 17 Rubber Dam Clamp Fig. 2 |
| | 18 Rubber Dam Clamp Fig. 2A |
| | 19 Rubber Dam Clamp Fig. 7 |

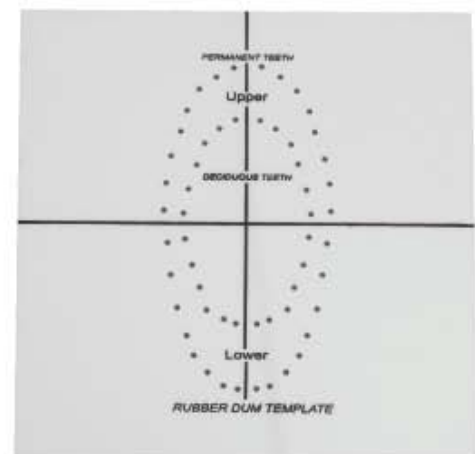

DE-1488
Rubber Dum Template



RUBBER DAM CLAMPS

- Кляммера для коффердама
- Crampons pour digue
- Kofferdam Klammern
- Кляммера для коффердама
- Grapas para dique de caucho
- المشابك السد المطاط



DE-1489
Fig. 15



DE-1490
Fig. 18



DE-1491
Fig. 24



DE-1492
Fig. 25



DE-1493
Fig. 26



DE-1494
Fig. 28



DE-1495
Fig. 30



DE-1496
Fig. 31



DE-1497
Fig. 51



DE-1498
Fig. 138



DE-1499
Fig. 139



DE-1500
Fig. 200



DE-1501
Fig. 201



DE-1502
Fig. 202



DE-1503
Fig. 203



DE-1504
Fig. 204



DE-1505
Fig. 205



DE-1506
Fig. 3



DE-1507
Fig. W3



DE-1508
Fig. 4



DE-1509
Fig. 56A



DE-1510
Fig. 7



DE-1511
Fig. 7A



DE-1512
Fig. 8



DE-1513
Fig. 8A



DE-1514
Fig. W8A



DE-1515
Fig. 10



DE-1516
Fig. 11



DE-1517
Fig. 12A



DE-1518
Fig. 13A



DE-1519
Fig. 14



DE-1520
Fig. 14A



DE-1521
Fig. 14AN



DE-1522
Fig. 22



DE-1523
Fig. 27



DE-1524
Fig. 207



DE-1525
Fig. 29



DE-1526
Fig. 206



DE-1527
Fig. 208



DE-1528
Fig. 209



DE-1529
Fig. 1



DE-1530
Fig. 1A



DE-1531
Fig. 2



DE-1532
Fig. 2A



DE-1533
Fig. W2A



DE-1534
Fig. 0



DE-1535
Fig. 00



DE-1536
Fig. 210



DE-1537
Fig. 211



DE-1538
Fig. 212



DE-1539
Fig. 6



DE-1540
Fig. 9



DE-1541
Fig. N06



DE-1542
Fig. U67



DE-1543
Fig. 214



DE-1544
Fig. P1



DE-1545
Fig. P2



DE-1546
Fig. G-1



DE-1547
Fig. G-2

CROWN REMOVER

- Инструменты для удаления коронок
 - Arrache-couronnes
 - Teleskopkronenzangen
- Инструменты для видалення коронок
 - Arranca-corona
 - مزيلات التاج



DE-1548
Crown Spreaders



DE-1550
Universal
Fig. 0



Manual Crown Removers
Handle with 3 tips **DE-1551**
Only 3 tips **DE-1552 to DE-1554**



DE-1552



DE-1553



DE-1554



Manual Crown Removers
Handle with 3 tips **DE-1555**
Only 3 tips **DE-1556 to DE-1558**



DE-1556



DE-1557



DE-1558



DE-1559
Manual Crown
Remover



DE-1560
Manual Crown Remover



DE-1561
Complete with 3 tips
and tightening keys

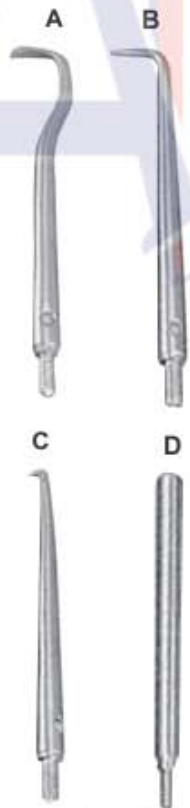

semi-automatic crown
& bridge remover



DE-1562



A

B

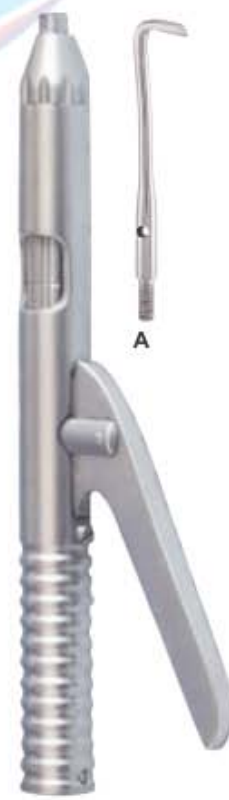

DE-1563
Manual Crown Remover



A

B

C

D

E

MATRIX RETAINERS

- Матрицедержатели
 - Porte Matrices
 - Matrizenspanner
- Матрицеутримувачи
 - Porta Matrices
 - مصفوفة الختم



DE-1564
Fig. 5
Ivory 8
5 cm



DE-1565
Fig. 6
Ivory 8
6 cm



DE-1566
Fig. 7
Ivory 8
7 cm



DE-1567
Fig. 1
Tofflemire-Universal



DE-1568



DE-1569



DE-1570



DE-1571
Fig. 2
Tofflemire-Junior



DE-1572
Fig. 3
Tofflemire-Senior



DE-1573
Narrow



DE-1574
Wide

Siqveland Retainers

Amalgam Well



DE-1575
Stainless Steel
Amalgam Well



DE-1576
Ivory 12



DE-1577
Ivory 1



DE-1578
Ivory



DE-1579
Elliot

AMALGAM INSTRUMENTS



- Инструменты для амальгамы
- Instruments pour amalgame
- Amalgamis'instrumente
- Инструменти для амальгами
- Instrumentos para amalgama
- الصكوك الملقم



DE-1580
Fig. 10
165mm
English pattern



DE-1581
Fig. 1
185mm
German pattern



DE-1582
Fig. 1
150mm
Swiss pattern



DE-1583
Fig. 1
150mm



DE-1584
Fig. 2
150mm, 45°



DE-1585
Fig. 3
140mm, 90°



DE-1586
Chip Blower



DE-1587



DE-1588



DE-1589



DE-1590
Water Syringe



AMALGAM INSTRUMENTS

- Инструменты для амальгамы
- Instruments pour amalgame
- Amalgamis/instrumente
- Инструменты для амальгами
- Instrumentos para amalgama
- الصكوك المنغم

AMALGAM CARRIERS

TIP SIZES FOR DISTAL OR SINGLE-END

1.5 mm



DE-1592
Mini/
Single-End

2.0 mm



DE-1593
Regular
Single-End

2.8 mm



DE-1594
Large
Single-End

1.5 mm



DE-1595
Mini
Distal

2.0 mm



DE-1596
Regular
Distal

TIP SIZES FOR DOUBLE-END

1.5 mm



2.0 mm
DE-1597
Mini/
Regular

2.8 mm



2.0 mm
DE-1598
Large/
Regular

3.2 mm



2.0 mm
DE-1599
Jumbo/
Regular



DE-1600
Amalgam
Well

DE-1591
Single-End

TIP SIZES FOR DOUBLE-END

DE-1601 - 1.5mm-2.0mm
DE-1602 - 2.0mm-2.8mm
DE-1603 - 2.0mm-3.2mm

DE-1604 - 1.0mm-2mm
DE-1605 - 2.0mm-3mm
DE-1606 - 2.0mm-4mm

DE-1607 - 1.5mm-2.0mm
DE-1608 - 2.0mm-2.8mm
DE-1609 - 2.0mm-3.2mm

DE-1610 - 1.0mm-2mm
DE-1611 - 2.0mm-3mm
DE-1612 - 2.0mm-4mm

DE-1613 - 1.5mm-2.0mm
DE-1614 - 2.0mm-2.8mm
DE-1615 - 2.0mm-3.2mm

DE-1616 - 1.0mm-2mm
DE-1617 - 2.0mm-3mm
DE-1618 - 2.0mm-4mm

DE-1619 - 1.5mm-2.0mm
DE-1620 - 2.0mm-2.8mm
DE-1621 - 2.0mm-3.2mm

DE-1622 - 1.0mm-2mm
DE-1623 - 2.0mm-3mm
DE-1624 - 2.0mm-4mm

DE-1625 - 1.5mm
DE-1626 - 2.0mm
DE-1627 - 2.0mm
DE-1628 - 3.0mm



ROOT PLANNING FILES



DE-1641
Kramer-Nevins
Bone Chisel



DE-1642
Kramer-Nevins
Bone Chisel



DE-1643
Molt 18.5cm
Auto Clavable
Plastic Tips.



DE-1644
Mead 18.5cm
Non Auto Clavable
Plastic Tips.



DE-1645
Miller



DE-1646
Miller

BONE FILES



DE-1647
Miller 21



DE-1648
Miller 1X
cross cut



DE-1649
Miller 2X
cross cut



DE-1650
Miller 52



DE-1651
Wahl 1

PERIODONTAL INSTRUMENTS



- Инструменты пародонтологические
- Instruments pour la parodontologie
- Instrumente für die Parodontologie
- Інструменти пародонтологічні
- Instrumentos para periodoncia
- الصكوك اللثة

PERIOSTEEL ELEVATORS

DE-1652
Ohl 10

DE-1653
Howard 9H

DE-1654
Freer

DE-1655
Freer 15

DE-1656
Freer 16

DE-1657
10.0mm

DE-1658
6.4mm

DE-1659
3.0mm

DE-1658
Raspator, Raspatory
Length 175 mm

DE-1660
4.0mm

DE-1661
5.0mm

DE-1662
7.0mm

DE-1663 3mm
DE-1664 4mm
DE-1665 5mm
DE-1666 6mm

DE-1667 3mm
DE-1668 4mm
DE-1669 5mm
DE-1670 6mm

DE-1671 3mm
DE-1672 4mm
DE-1673 5mm
DE-1674 6mm

DE-1675 3mm
DE-1676 4mm
DE-1677 5mm
DE-1678 6mm

DE-1660
Raspator, Williger
Length 170 mm, different widths
(4 mm, 5 mm or 7 mm)

Partsch 140 mm
DE-1663 3mm
DE-1664 4mm
DE-1665 5mm
DE-1666 6mm

Partsch 170 mm
DE-1667 3mm
DE-1668 4mm
DE-1669 5mm
DE-1670 6mm

Partsch 140 mm
DE-1671 3mm
DE-1672 4mm
DE-1673 5mm
DE-1674 6mm

Partsch 170 mm
DE-1675 3mm
DE-1676 4mm
DE-1677 5mm
DE-1678 6mm

PERIODONTAL INSTRUMENTS

- Инструменты пародонтологические
- Instruments pour la parodontologie
- Instrumente für die Parodontologie
- Инструменти пародонтологічні
- Instrumentos para periodoncia
- الصكوك اللثة

To separate tissue tooth or bone. tp hold tissue away from surgical site.

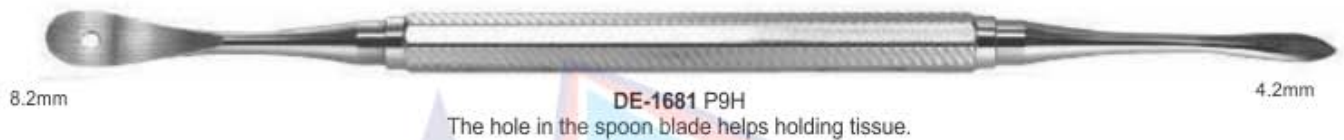

PERIODONTAL INSTRUMENTS



- Инструменты пародонтологические
- Instruments pour la parodontologie
- Instrumente für die Parodontologie
- Інструменти пародонтологічні
- Instrumentos para periodoncia
- الصكوك اللثة



DE-1689



DE-1690
P24G



DE-1691
titanium Periosteal Elevator for Implan5



DE-1692
S1



DE-1693
Hirschfeld



DE-1694
9S



10mm

DE-1695
Selden

13mm



4.8 mm

Prichard

10.6 mm

DE-1696
Friedmann



6.9 mm

DE-1697
Schmidlin



SCALPEL HANDLES

- Ручки для скальпелей
- Manches de bistouris
- Skalpellgriffe
- Ручки для скальпелів
- Mangos de bisturi
- مشرط مقابض



DE-1698
Fig.3
12.7cm



DE-1699
Fig.3G
12.7cm



DE-1700
Fig.4
13.7cm



DE-1701
Double Handle
No.4 + No.3
16.3cm



DE-1702
Fig. 7
16.5cm



DE-1703
Scalpel Handle Straight
for blades #10-15
14.5cm



DE-1704
Micro Surgical Scalpel
Handle titanium
13.5cm



DE-1705
Fig. 5
14.5cm



DE-1706
Fig. 5A
14.5cm



Locks At 90°, 60°, 30°,
Straight, 120°, 150°, 180°,
Angles



DE-1707
6 Way Adjustable Angled
Scalpel Handle

MALLETS - PLASTER SHEARS - SAWS & BLADES



DE-1708
Metal tip
220 mm
Hammer With Wooden Handle



DE-1709
Metal tip
220 mm



DE-1710
1
For plaster



DE-1711
2
For metal



DE-1712
Fret saw
250 mm



DE-1713
Small
Saw Blades



DE-1714
Large
Saw Blades



DE-1715
Ceri Saw



Special Inox
DE-1716 170mm
DE-1717 200mm



DE-1718
Plaster Shears
200 mm



Crucible Tongs
DE-1719 250 mm
DE-1720 320 mm



DE-1721
Ceri Saw
180 mm



DE-1722
Blade
0,12x5 mm
Conf. 12 pcs



DE-1723
Blade
0,25x5 mm
Conf. 12 pcs



DE-1724
Blade
0,25x3 mm
Conf. 12 pcs



ORTHODONTIC INSTRUMENTS



Behind Every Smile is a Story

- QUALITY - ЯКІСТЬ
- PRECISION - ТОЧНІСТЬ
- ACCURACY - ПРАВИЛЬНІСТЬ
- DURABILITY - ЗНОСОСТІЙКІСТЬ

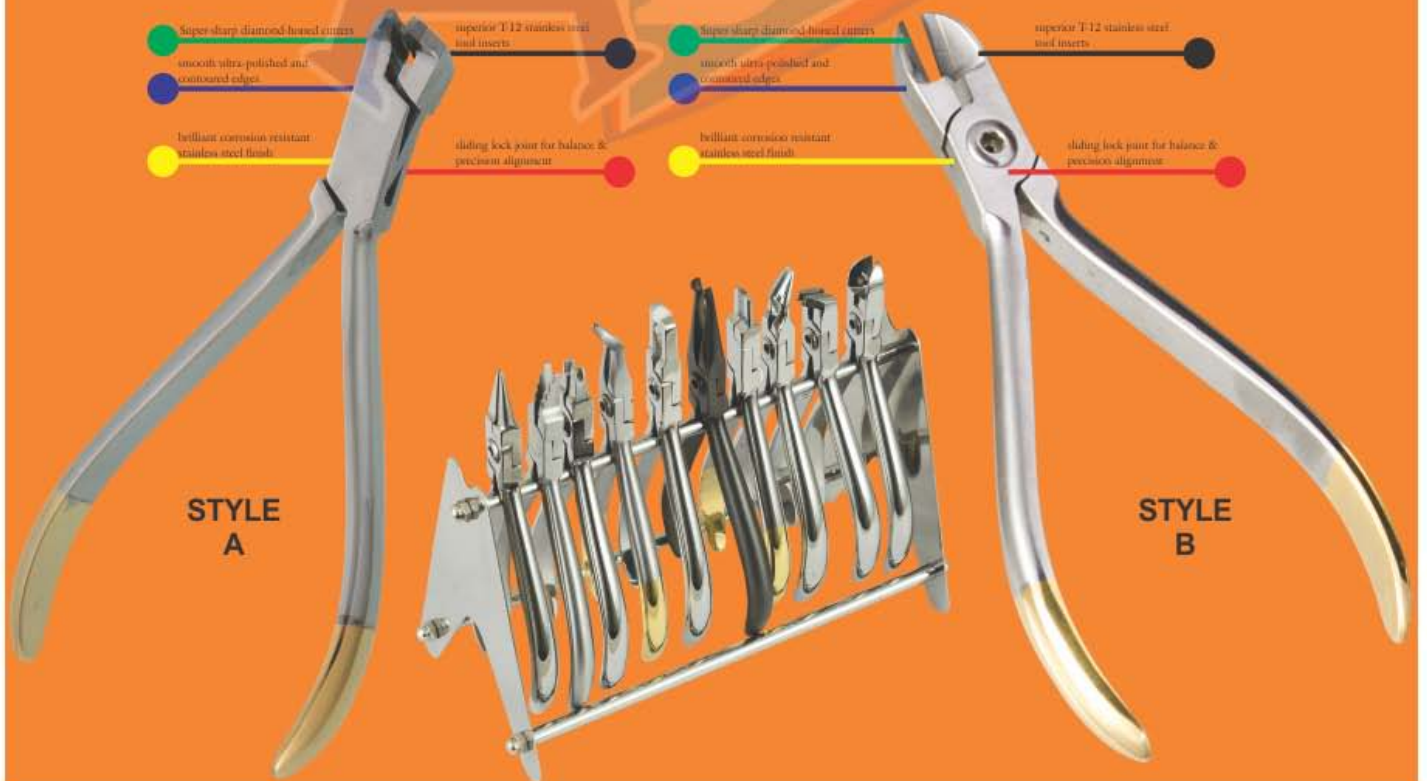

STYLE A

STYLE B

ORTHODONTIC INSTRUMENTS



- Инструменты ортодонтические
- Instrumentos Ortodonticos
- Orthodontische Instrumente
- Инструменти ортодонтични
- Instruments Orthodontiques
- أدوات تقويم الأسنان



DE-1800
Height Gauge 0.18
Aluminum



DE-1801
Height Gauge 0.22
Aluminum



DE-1802
Height Gauge 0.18
Stainless Steel



DE-1803
Height Gauge 0.22
Stainless Steel



DE-1804
Moveable
Height Gauge



DE-1805
Endo Finger
Ruler Span
Measure Scale



DE-1806
Endo Finger
Ruler Span
Measure Scale



DE-1807
Endo Finger
Ruler Span
Measure Scale



DE-1808
Positive
Postioner



DE-1809
Strip Saw



DE-1810
Bone Bracket Gauge



DE-1811
Endo Finger Ruler
Span Measure Scale



DE-1812
Endo Finger Ruler
Span Measure Scale

ORTHODONTIC INSTRUMENTS

- Инструменты ортодонтические
- Instrumentos Ortodonticos
- Orthodontische Instrumente
- Инструменти ортодонтични
- Instruments Orthodontiques
- أدوات تقويم الأسنان



DE-1813
Measuring Loop
angled, length
175 mm,
measuring range
0 - 40 mm



DE-1814
Measuring Loop
straight length
175 mm,
measuring range
0 - 40 mm



DE-1815
Measuring loop, Castroviejo
angled, length 175 mm,
measuring range 0 - 40 mm,
with window



DE-1816
Measuring Loop
straight length 90 mm,
measuring range
0 - 40 mm,

DE-1817
Castroviejo Calipers
20mm
90mm



DE-1818
Measuring Loop
angled, length 90 mm,
measuring range
0 - 40 mm,

DE-1819
Castroviejo Calipers
20mm, 45°
90mm



DE-1820
Castroviejo Calipers
20mm
90mm



DE-1821
Fig. 1
Iwanson
spring caliper
For metal and
porcelain.



DE-1822
Fig. 2
Iwanson
spring caliper
For wax.

ORTHODONTIC INSTRUMENTS



- Инструменты ортодонтические
- Instrumentos Ortodonticos
- Orthodontische Instrumente
- Инструменти ортодонтични
- Instruments Orthodontiques
- أدوات تقويم الأسنان



DE-1823
Boley Gauge



DE-1824
Vernier Gauge



DE-1825
Aluminium Caliper
up to 200mm



DE-1826
Boley Gauge



DE-1827
Delux Boley
Gauge



DE-1828
Beerendonk
130mm
Mini Gauge



DE-1829
Compasso
De Willis



DE-1830
Dentaurum
Ruler



DE-1831
Ruler Wedge



DE-1832
Ruler

ORTHODONTIC INSTRUMENTS

- Инструменты ортодонтические
- Instrumentos Ortodonticos
- Orthodontische Instrumente
- Инструменти ортодонтичні
- Instruments Orthodontiques
- أدوات تقويم الأسنان

Bracket Holder Tweezers



DE-1833
Deluxe Bracket
Holder Tweezers



DE-1834
Deluxe Bracket
Holder Tweezers



DE-1835
Direct Bond Bracket
Holder Tweezers



DE-1836
Bracket Tweezers
Slot Aligner



DE-1837
Direct Bond
Bracket Holder
Tweezers, Small Tip



DE-1838
Exact Bracket
Holder Tweezers



DE-1839
Bracket Placing
Tweezers



DE-1840
Easy Access
Tweezers



DE-1841
Bracket Placer
Tweezers
(Extra Fine Tip)



DE-1842
Deluxe Bracket
Holder Tweezers
135mm



DE-1843
Easy Access
Tweezers



DE-1844
Slipper
Tweezers



DE-1845
Direct Bonding
Bracket Holders
135mm



DE-1846
Direct Bonding
Bracket Holders
136mm



DE-1847
Direct Bonding
Bracket Holders
135mm



DE-1848
Deluxe Bracket
Holder



DE-1849
Direct Bonding
Bracket Holders
140mm

ORTHODONTIC INSTRUMENTS



- Инструменты ортодонтические
- Instrumentos Ortodonticos
- Orthodontische Instrumente
- Инструменти ортодонтични
- Instruments Orthodontiques
- أدوات تقويم الأسنان



DE-1850
Band seater
auto cleavable



DE-1851
Band seater
auto cleavable
Triangle Shape



DE-1852
Band seater
auto cleavable
Square Shape



DE-1853
Band seater
auto cleavable
Round Shape



DE-1854
Mershon Band
Pusher
140mm



DE-1855
Band seating &
removing
instruments



DE-1856
Ortho Light double
ended
ligature director
scaler



DE-1857
Ortho Light Band
Pusher Scaler



DE-1858
Band Seating &
Removing
Silicon Grip



DE-1859
Ligature Instrument
Silicon Grip



DE-1860
Elastic Instrument
Silicon Grip



DE-1861
Distal Bender
Silicon Grip



DE-1862
Distal Bender
Silicon Grip



DE-1863
Distal Bender
Silicon Grip

ORTHODONTIC INSTRUMENTS

- Инструменты ортодонтические
- Instrumentos Ortodonticos
- Orthodontische Instrumente
- Инструменти ортодонтични
- Instruments Orthodontiques
- أدوات تقويم الأسنان



DE-1864
Ortho light scaler double ended



DE-1865
Ortho light scaler double ended



DE-1866
Ortho light scaler double ended



DE-1867
Twiel-on elastic module instrument



DE-1868
Twiel-on elastic module instrument



DE-1869
Schure Band Seater



DE-1870
Ortho light scaler



DE-1871
Ortho light scaler



DE-1872
Ortho light scaler heavy



DE-1873
Ortho instrument



DE-1874
Ortho instrument

ORTHODONTIC INSTRUMENTS



- Инструменты ортодонтические
- Instrumentos Ortodonticos
- Orthodontische Instrumente
- Инструменти ортодонтични
- Instruments Orthodontiques
- أدوات تقويم الأسنان



DE-1875
Ortho Light double ended
ligature director



DE-1876
Ortho Light double ended ligature scaler director tivate coil spring
are remove modules with one instruments



DE-1877
Ortho band pusher scaler



DE-1878
Ortho ligature director single ended



DE-1879
Ortho Light double ended ligature
director scaler



DE-1880
Ortho Light double ended ligature scaler/director
tivate coil spring are remove modules with one instruments



DE-1881
Ortho Light double ended ligature director



DE-1882
Ortholite Ligature Director Scaler



DE-1883
Ortho light ligature director double ended



DE-1884
Double ended cement spatula



DE-1885
Ortho light scaler single ended

PLIERS FOR ORTHODONTICS & PROSTHETICS

- Щипцы для ортодонтии и протезирования
- Pincers pour l'orthodontie et la prothèse
- Zangen für Kieferorthopädie und Prothetik
- Щипці для ортодонції та протезування
- Alicates para ortodoncia y prótesis
- كمشة لتقويم الأسنان برومبیتس

BOX JOINT PLIERS

DE-1886

Universal Dolphin Style
Wire Bending & cutting pliers



DE-1892

Bracket Removing Plier curved
Bracket Removing Plier curved for
easy removal of brackets in the
posterior region. Length 130mm



DE-1887 Band Removing Plier

The curved blade of the band
removing plier can strip easily
and gently remove directly to
the tooth. Length 130mm



DE-1893

Young Wire Bending &
Loop Forming Pliers



DE-1888

Tweed Loop
forming Pliers



DE-1894

Wire Bending &
Loop Forming Pliers



DE-1889

How Plier curved
Universally usable tool for
the multiband technology for
wires up to .028".
Length 130mm



DE-1895

Adams, small wire bending
and loop forming Pliers



DE-1890 How Plier

Universally usable tool for the
multiband technology for wires
up to .028".
Length 135mm



DE-1896

Bracket Removing Plier Round Box
Bracket removing plier for comfortable
and quick removal of the brackets.
Length 135mm



DE-1891

Nance Loop
forming Pliers



DE-1897

Weingart Plier medium
Weingart plier that are ideal due to
their curved plier tip for setting sheets and
is capable of bending the ends.
Length 145mm



PLIERS FOR ORTHODONTICS & PROSTHETICS



- Щипцы для ортодонтии и протезирования
- Щипці для ортодонції та протезування
- Pincers pour l'orthodontie et la prothèse
- Alicates para ortodoncia y prótesis
- Zangen für Kieferorthopädie und Prothetik
- كمانشة لتقويم الأسنان بروتستیس

BOX JOINT PLIERS

DE-1898 Adams Plier Round Box
Adams pliers for bending wire arches and bends right angles for wires up to .022", .025 tip to beak. Length 125mm



DE-1904 Adams Plier
Adams pliers for bending wire arches and bends right angles for wires up to .022", .025 tip to beak. Length 125mm



DE-1899 Falcon Beak Contouring Pliers.



DE-1905 Tweed Loop Formin Pliers



DE-1900
wires up to 0.020" / 0.7mm.



DE-1906 Bird Beak Plier Standard
Bird Beak Wire bending plier without notches, which is suitable as a universal utility tool. Length 125mm



DE-1901 Johnson Contouring Pliers



DE-1907 Mini Ligature cutters



DE-1902 Aderer Large wire bending and loop forming pliers



DE-1908 Small Fluch-cut distal and cutting Pliers
with safety hold fitted with un-breakable, corrosion resistant and durable stainless steel tips



DE-1903 Tweed / angle rectangular arch forming & Torquing pliers



DE-1909 Large Fluch-cut distal and cutting Pliers
with safety hold fitted with un-breakable, corrosion resistant and durable stainless steel tips



PLIERS FOR ORTHODONTICS & PROSTHETICS

- Щипцы для ортодонтии и протезирования
- Pincers pour l'orthodontie et la prothèse
- Zangen für Kieferorthopädie und Prothetik
- Щипці для ортодонції та протезування
- Alicates para ortodoncia y prótesis
- كمشة لتقويم الأسنان برومبشيس

BOX JOINT PLIERS

DE-1910
Tweed / Angel
1.78mm (.070") wide tips arch
forming and torquing pliers



DE-1916
Contouring Plier



DE-1911
Tweed / Angel
1.78mm (.070") wide tips arch
forming and torquing pliers



DE-1917
Bands & Crowns Plier
in order to skirt



DE-1912
Lingual / Palatal arch
forming pliers



DE-1918
Ligature Forming Pliers



DE-1913
Aderer
Facebow loop forming Pliers



DE-1919
for double back and triple back
bands in 0.30" / 0.76mm & 0.36"
/ 0.91mm lingual arch wires



DE-1914
Waldsavhs wire bending
and cutting pliers



DE-1920
Bird Beak Wire Bending
& cutting pliers



DE-1915 Aderer Plier
For the manufacturing of appliances and
activation of wires for wires up to .030" .fine
tip and up to .036" mean tip.
Length 130mm



DE-1921
Weingart Plier medium
Weingart plier that are ideal due to
their curved tip for setting sheets and
is capable of bending the ends.
Length 145mm



PLIERS FOR ORTHODONTICS & PROSTHETICS



- Щипцы для ортодонтии и протезирования
- Pincas pour l'orthodontie et la prothèse
- Zangen für Kieferorthopädie und Prothetik
- Щипці для ортодонції та протезування
- Alicates para ortodoncia y prótesis
- كمانشة لتقويم الأسنان بروسیتیس

L-KEY JOINT PLIERS



DE-1922
Distal end cutter with safety hold, mini head, long handles.
fitted with un-breakable, corrosion resistant and durable stainless steel tips

- 0.30 mm to 0.50 mm (.012" to .020")
- Max. 0.46 mm x 0.64 mm (.018" x .025")
- ⊗ 0.38 mm to 0.53 mm (.0155" to .0215")
- ⊗ Max. 0.53 mm x 0.64 mm (.021" x .025")



DE-1926
Soft wire and ligature cutter, 15° angled fitted with un-breakable, corrosion resistant and durable stainless steel tips

- ⌋ .25 mm to .38 mm (.010" to .015")



DE-1923
Flush-cut distal end cutter with safety hold fitted with un-breakable, corrosion resistant and durable stainless steel tips

- 0.30 mm to 0.50 mm (.012" to .020")
- Max. 0.46 mm x 0.64 mm (.018" to .025")



DE-1927
Soft wire and ligature cutter, 45° angled fitted with un-breakable, corrosion resistant and durable stainless steel tips

- ⌋ .25 mm to .38 mm (.010" to .015")



DE-1924
Soft wire and ligature cutter, Mini fitted with un-breakable, corrosion resistant and durable stainless steel tips

- ⌋ .25 mm to .38 mm (.010" to .015")



DE-1928
Hard wire cutter, straight Fitted with un-breakable, corrosion resistant and durable stainless steel tips

- 0.30 mm to 0.50 mm (.012" to .020")
- Max. 0.56 mm x 0.71 mm (.022" x .028")



DE-1925
Soft wire and ligature cutter, standard fitted with un-breakable, corrosion resistant and durable stainless steel tips

- ⌋ .25 mm to .38 mm (.010" to .015")



DE-1929
Hard wire cutter, 15° angled Fitted with un-breakable, corrosion resistant and durable stainless steel tips

- 0.30 mm to 0.50 mm (.012" to .020")
- Max. 0.56 mm x 0.71 mm (.022" x .028")



DE-1930
Hard wire cutter, 15° angled Non-autoclavable

- 0.30 mm to 0.50 mm (.012" to .020")
- Max. 0.56 mm x 0.71 mm (.022" x .028")

PLIERS FOR ORTHODONTICS & PROSTHETICS

- Щипцы для ортодонтии и протезирования
- Pincers pour l'orthodontie et la prothèse
- Zangen für Kieferorthopädie und Prothetik
- Щипці для ортодонції та протезування
- Alicates para ortodoncia y prótesis
- مكاشة لتقويم الأسنان برومبیتس

L-KEY JOINT PLIERS

	<p>DE-1931 Band removing pliers</p>		<p>DE-1936 Weingart-mini Utility Pliers</p> <ul style="list-style-type: none"> ● 0.30 mm to 0.50 mm (.012" to .020") ■ Max 0.56 mm x 0.71 mm (.022" x .028")
	<p>DE-1932 Bracket removing pliers angled</p>		<p>DE-1937 Weingart Utility Pliers</p> <ul style="list-style-type: none"> ● 0.30 mm to 0.50 mm (.012" to .020") ■ Max 0.56 mm x 0.71 mm (.022" x .028")
	<p>DE-1933 Bracket removing pliers straight</p>		<p>DE-1938 How Straight Utility Pliers</p> <ul style="list-style-type: none"> ● 0.30 mm to 0.50 mm (.012" to .020") ■ Max 0.56 mm x 0.71 mm (.022" x .028")
	<p>DE-1934 Bracket removing pliers with plastic tip</p>		<p>DE-1939 Angled Utility Pliers</p> <ul style="list-style-type: none"> ● 0.30 mm to 0.50 mm (.012" to .020") ■ Max 0.56 mm x 0.71 mm (.022" x .028")
	<p>DE-1935 Adhesive removing pliers</p>		<p>DE-1940 Wire bending and loop forming pliers Angled (Bird beak)</p> <ul style="list-style-type: none"> ● 0.30 mm to 0.50 mm (.012" to .020") ■ Max 0.56 mm x 0.71 mm (.022" x .028")

PLIERS FOR ORTHODONTICS & PROSTHETICS



- Щипцы для ортодонтии и протезирования
- Щипці для ортодонції та протезування
- Pincers pour l'orthodontie et la prothèse
- Alicates para ortodoncia y prótesis
- Zangen für Kieferorthopädie und Prothetik
- كاشطة لتقويم الأسنان بروسيتيس

L-KEY JOINT PLIERS



DE-1941
Multi-purpose pliers, bird beak,
De la rosa and cutter in one

- 0.30 mm to 0.50 mm (.012" to .020")
- Max. 0.46 mm x 0.56 mm (.018" x .022")



DE-1946
Stop pliers V-Bebd - 1mm

- 0.30 mm to 0.50 mm (.012" to .020")
- Max. 0.43 mm x 0.56 mm (.017" x .028")



DE-1942
Cinch Back / tie back
Distal end bending pliers

- 0.30 mm to 0.50 mm (.012" to .020")
- Max. 0.56 mm x 0.71 mm (.022" x .028")



DE-1947
Lingual / palatal arch forming plies

- 0.76 mm (.030") / 0.91 mm (.036")



DE-1943
Hammer head
Distal end bending pliers

- 0.30 mm to 0.50 mm (.012" to .020")
- Max. 0.56 mm x 0.71 mm (.022" x .028")



DE-1948
Torquing pliers set



DE-1944
Nance
Loop forming pliers

- 0.36 mm to 0.71 mm (.014" to .028")
- Max. 0.56 mm x 0.71 mm (.022" x .028")



DE-1949
Tweed / angel
Rectangular arch forming and
torquing pliers

- 0.30 mm to 0.71 mm (.012" to .028")
- Max. 0.56 mm x 0.71 mm (.022" x .028")



DE-1945
Detailing step pliers / Bayonet
bending pliers - 1mm

- 0.30 mm to 0.50 mm (.012" to .020")
- Max. 0.56 mm x 0.71 mm (.022" x .028")



DE-1950
Surgical ball hook crimping pliers,
angled



DE-1951
Surgical ball hook crimping
pliers, straight



PLIERS FOR ORTHODONTICS & PROSTHETICS

- Щипцы для ортодонтии и протезирования
- Pincers pour l'orthodontie et la prothèse
- Zangen für Kieferorthopädie und Prothetik
- Щипці для ортодонції та протезування
- Alicates para ortodoncia y prótesis
- كمانة لتقويم الأسنان برومبیتس

L-KEY JOINT PLIERS



DE-1952
Aderer Clamp three jaw wire bending plier for contouring and bending wire up to .30"/.76mm.



DE-1958
Falcon beak contouring plier.

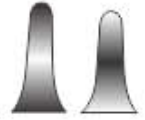

DE-1953
Bird beak plier for bending round, square and rectangle wire up to .30"/.76mm.

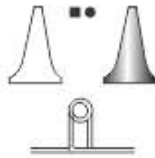

DE-1959
For placement and removal of arch wires, pins and other auxiliaries.



DE-1954
Bird beak plier for light wire bending round, square and rectangular up to .016"/0.41mm.

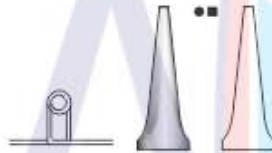

DE-1960
For placement and removal of arch wires, pins and other auxiliaries in angle design



DE-1955
Double Rounded jaw bending pliers, hooks and wire up to .020"/0.51mm.

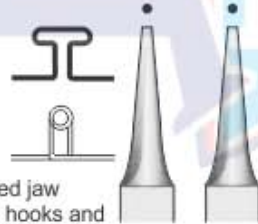

DE-1961
contouring Plier.



DE-1956
Adams pliers for hooks and bending wire up to .030"/0.76mm.

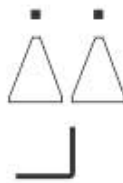

DE-1962
Bending plier. In order to skirt molares bands. With grooved. Recommended wire. 016", 018" and 022" 0.41mm, 0.46mm and 0.56mm



DE-1963
Loop forming in four length 3,4,5 & 6 mm wire capacity 0.22", 56mm.



DE-1957
Johnson pliers for crown band contouring



DE-1964
Arch bending plier design for convenient handling of square or rectangular wire, .020" / 0.51mm.



PLIERS FOR ORTHODONTICS & PROSTHETICS



- Щипцы для ортодонтии и протезирования
- Pincas pour l'orthodontie et la prothèse
- Zangen für Kieferorthopädie und Prothetik
- Щипці для ортодонції та протезування
- Alicates para ortodoncia y prótesis
- كماشة لتقويم الأسنان بروسیتیس

LAP & L-KEY JOINT PLIERS



DE-1965
In order to skirt bands and crowns.



DE-1966
Wires up to .020" / 0.7mm.

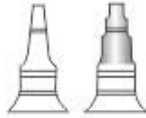

DE-1967
Round and concave plier for loop forming and banding wire up to .20" / .051mm.



DE-1968
Bending for round square or rectangular wire up to 0.30"/0.76mm



DE-1969
for double back and triple back bands in 0.30" / .76mm & 0.36" / .91mm lingual arch wires.



DE-1970
Detailing step plier double-sided offset beak permits bayonet bends. Creates right hand or left hand step-up or stepdown at 1/8, 1/4, or 1mm increments.



DE-1971
"V" bend stop special design makes 1mm "v" bends to shorten archwires or provide a positive stop. Excellent for placing stops in titanium wires. For round or rectangular wires up to .025"



DE-1972
Angle how plier efficient utility plier with serrated beaks for a firm grip. 45 angled tips to access hard to reach areas.



DE-1973
Weingardt plier serrated tips hold wires firmly at a convenient working angle. Tapered beaks fit easily between brackets and hard to reach areas. Our most popular utility plier.



DE-1974
Pin & Ligature Cutters TC.



DE-1975
Mini Pin & Ligature Cutter TC.



DE-1976
Standard Ligature Cutter TC.



DE-1977
V Bend Stop Plier TC.



DE-1978
Angled Direct Bond Bracket Remover TC.



DE-1979
Cutter Str.



Distal Cutter 14cm
DE-1980 2.5 mm
DE-1981 3.0 mm
DE-1982 3.0 mm



DE-1983
Arrow Clasp Forming Pliers 12.0cm



DE-1984
Schwarz 12.5cm





DISTAL END, WIRE CUTTERS & BRACKET REMOVER PLIERS

DE-1985
Distal end Cutter, Safety Hold Plier
(Ideal for Cutting Wire) TC.



DE-1986
Hook Crimping Plier Angled
Straight TC.



DE-1987
3 Prong Clasp Adjustable
Plier TC.



DE-1988
Utility Plier Weingart TC.



DE-1989
Direct Bracket Remover
TC.



DE-1990
Straight Direct Bond Bracket
Remover TC.



DE-1991
Pin Holding Plier TC.



DE-1992
Hard wire cutters



DE-1993
Elastic Separating Plier
Round Handle



DE-1994
Elastic
Separating Plier



DE-1995 Str.
DE-1996 Cvd.
Smaha
Elastomeric
ligature
placing forceps
140 mm



DE-1997
Elastomeric
ligature placing
forceps with
groove
Falcon 140 mm



DE-1998
Elastomeric
ligature placing
forceps with
groove
Falcon 140 mm



PLIERS FOR ORTHODONTICS & PROSTHETICS



- Щипцы для ортодонтии и протезирования
- Pincers pour l'orthodontie et la prothèse
- Zangen für Kieferorthopädie und Prothetik
- Щипці для ортодонції та протезування
- Alicates para ortodoncia y prótesis
- كمامة لتقويم الأسنان بروسثیتیس

CUTTER, UTILITY PLIERS & WIRE FORMING PLIERS



DE-1999
Weingart Pliers



DE-2004
Adhesive
Removing Pliers



DE-2000
Slim Weingart
Pliers



DE-2005
Posterior Band Removing
Pliers - Long



DE-2001
How Pliers
Straight



DE-2006
Posterior Band Removing
Pliers - Short



DE-2002
How Pliers Offset

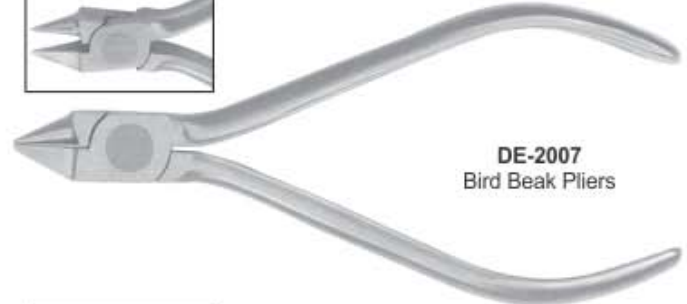

DE-2007
Bird Beak Pliers



DE-2003
Band seating Pliers

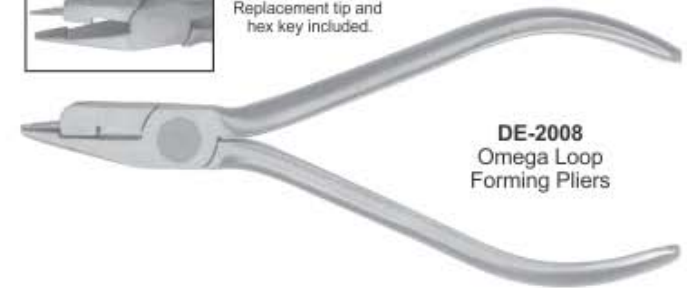

Replacement tip and
hex key included.

DE-2008
Omega Loop
Forming Pliers

- Щипцы для ортодонтии и протезирования
- Pincers pour l'orthodontie et la prothèse
- Zangen für Kieferorthopädie und Prothetik
- Щипці для ортодонції та протезування
- Alicates para ortodoncia y prótesis
- كمشة لتقويم الأسنان برومبئیس

CUTTERS



DE-2009
Hard
Wire Cutter 15



DE-2013
Mini Pin &
Ligature Cutter



DE-2010
Distal End Cutter
Flush Cut

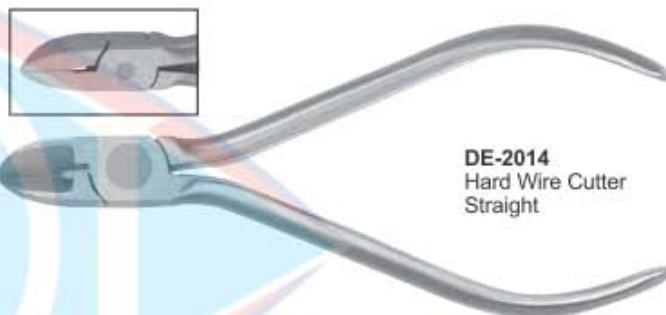
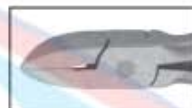

DE-2014
Hard Wire Cutter
Straight



DE-2011
Universal Cut & Hold
Distal End Cutter



DE-2015
Micro-Mini Pin &
Ligature Cutter



DE-2012
Pin & Ligature
Cutter



DE-2016
Cutter

PLIERS FOR ORTHODONTICS & PROSTHETICS



- Щипцы для ортодонтии и протезирования
- Pincas pour l'orthodontie et la prothèse
- Zangen für Kieferorthopädie und Prothetik
- Щипці для ортодонції та протезування
- Alicates para ortodoncia y prótesis
- كماشة لتقويم الأسنان بروسيٲيتيس



DE-2017
Three Jaw Pliers



DE-2021
Jarabak Pliers



DE-2018
Light Wore Bird Beak
Pliers with Groove



DE-2022
Hollow Chop
Contouring Pliers



DE-2019
Tweed loop
Forming Pliers



DE-2023
Lingual Arch
Forming Pliers



DE-2020
Arch Bending Pliers



DE-2024
Rectangular Arch
Bending Pliers

ORTHODONTICS PLIERS STANDS

- Ортодонтия Щипцы Подставки
- Supports de pinces d'orthodontie
- Kieferorthopädie Zangenständer
- Ортодонтия Щипці Підставки
- KFO Zangen Ständer
- تقويم الاسنان كمشاة تقف



DE-2025
Plier Stand
Stainless Steel.



DE-2026
Plier Stand
Stainless Steel.

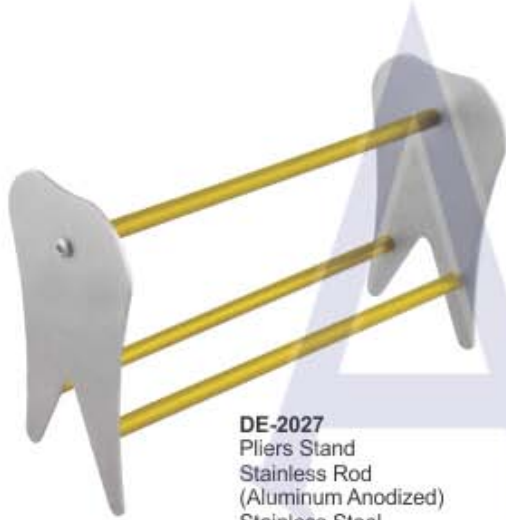

DE-2027
Pliers Stand
Stainless Rod
(Aluminum Anodized)
Stainless Steel



DE-2028
Plier Stand
Stainless Steel.



DE-2029
Plier Stand
Stainless Steel.



DE-2030
Plier Stand
Plastic

Normal Anatomy – Dental Implants

Bone Level Normal
(No Bone Loss)

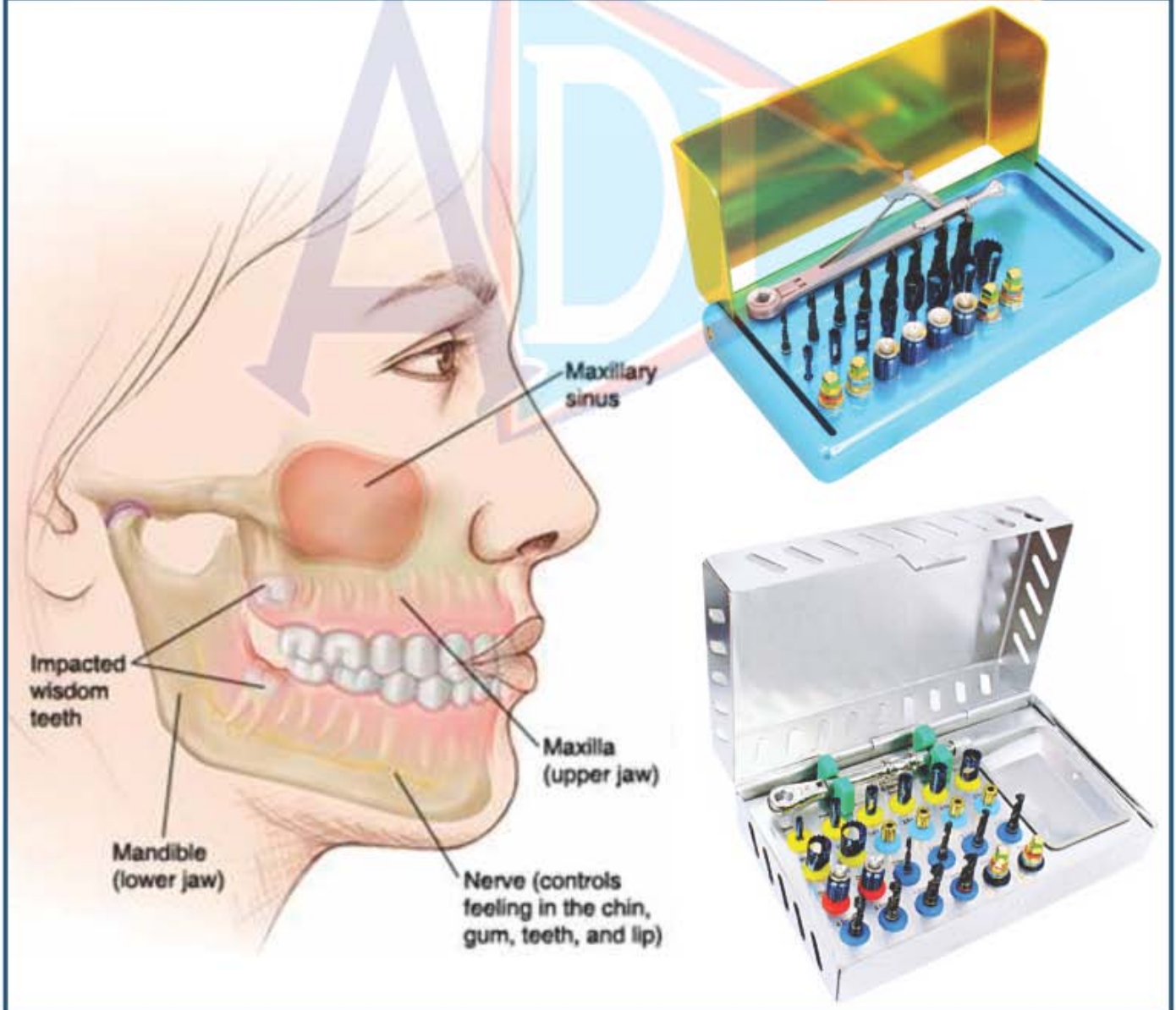
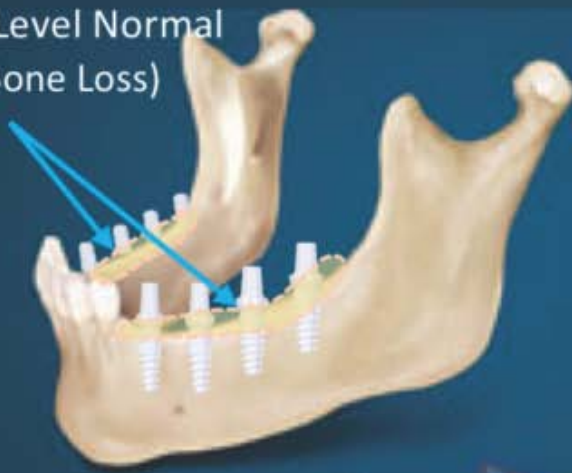

- Инструменты для имплантологии
 - Implantologie
 - Implantologie
- Инструменти для імплантології
 - Implantologia
 - زراعة الأسنان

IMPLANT GAGES



DE-2100
Multifunctional Meter
 Length 90 mm,
 different sizes,
 8-10-11mm,
 corrosion-resistant

DE-2101
Multifunctional Meter
 Length 90 mm,
 different sizes,
 5-13-15-17 mm,
 corrosion-resistant

DE-2102
Measuring Probe
 Length 170 mm,
 hand shape or flexible
 (6-8-10-14-16 mm),
 corrosion-resistant

DE-2103

DE-2104

DE-2105

DE-2106

IMPLANT GAGES



DE-2107

DE-2108

DE-2109

IMPLANTOLOGY



- Инструменты для имплантологии
- Implantologie
- Implantologie

- Инструменти для имплантології
- Implantologia
- زراعة الأسنان



DE-2110
Ridge Mapping
Double Caliper



DE-2111
Bone Thickness Gauge
40mm, 180mm



DE-2112
Osteometer
Measuring Forceps For Jaw
Ridge Width measurement, scale
on both sides, rustfree, autoclavable



DE-2113
Micro Boley
Gauge Twisted



DE-2114
Micro Boley
Gauge Straight



DE-2115
Ortho Ruler / Cone Socket

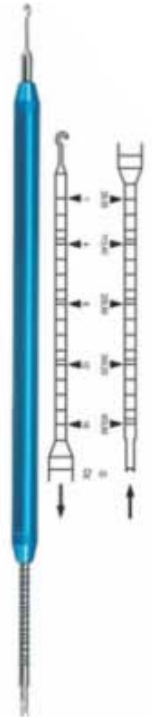

DE-2116
Dynamometer

- Инструменты для имплантологии
 - Implantologie
 - Implantologie
- Инструменти для імплантології
 - Implantologia
 - زراعة الأسنان

BLACK TITANIUM COLOUR COATED INSTRUMENTS



IMPLANTOLOGY



- Инструменты для имплантологии
- Implantologie
- Implantologie
- Инструменти для імплантології
- Implantologia
- زراعة الأسنان

BLACK TITANIUM COLOUR COATED INSTRUMENTS



DE-2125
A
Cosmetic
Contouring

DE-2126
B
Cosmetic
Contouring

DE-2127
C
Cosmetic
Contouring

DE-2128
D
Cosmetic
Contouring

DE-2129
F
Cosmetic
Contouring

DE-2130
Marginal Ridge
& Embrasure
Shaping Instrument

DE-2131
Occlusal
Anatomy
Instrument

- Инструменты для имплантологии
- Implantologie
- Implantologie
- Инструменти для імплантології
- Implantologia
- زراعة الأسنان

BLACK TITANIUM COLOUR COATED INSTRUMENTS

BURNISHERS

FREEDMAN BURNISHERS

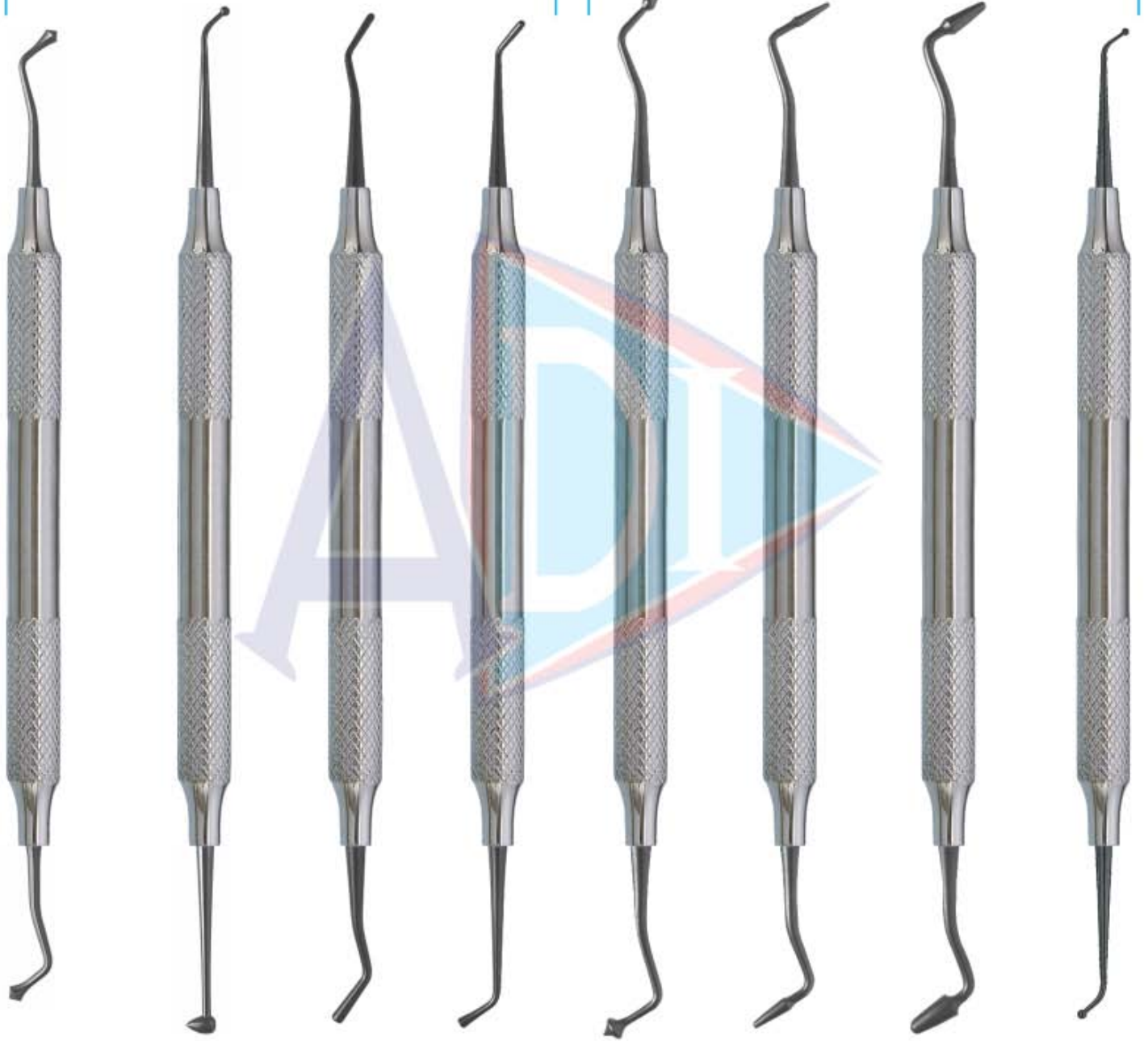

DE-2132
21B

DE-2133
27/29

DE-2134
2
Ladmore

DE-2135
3
Ladmore

DE-2136
Freedman
"Duckhead"

DE-2137
Freedman
Small Contact
Forming

DE-2138
Freedman
Large Contact
Forming

DE-2139
Small/
Medium Ball
Burnisher

IMPLANTOLOGY



- Инструменты для имплантологии
- Implantologie
- Implantologie
- Инструменти для імплантології
- Implantologia
- زراعة الأسنان

SINUS LIFT INSTRUMENTS HOLLOW HANDLE 9.5MM LENGTH 170MM

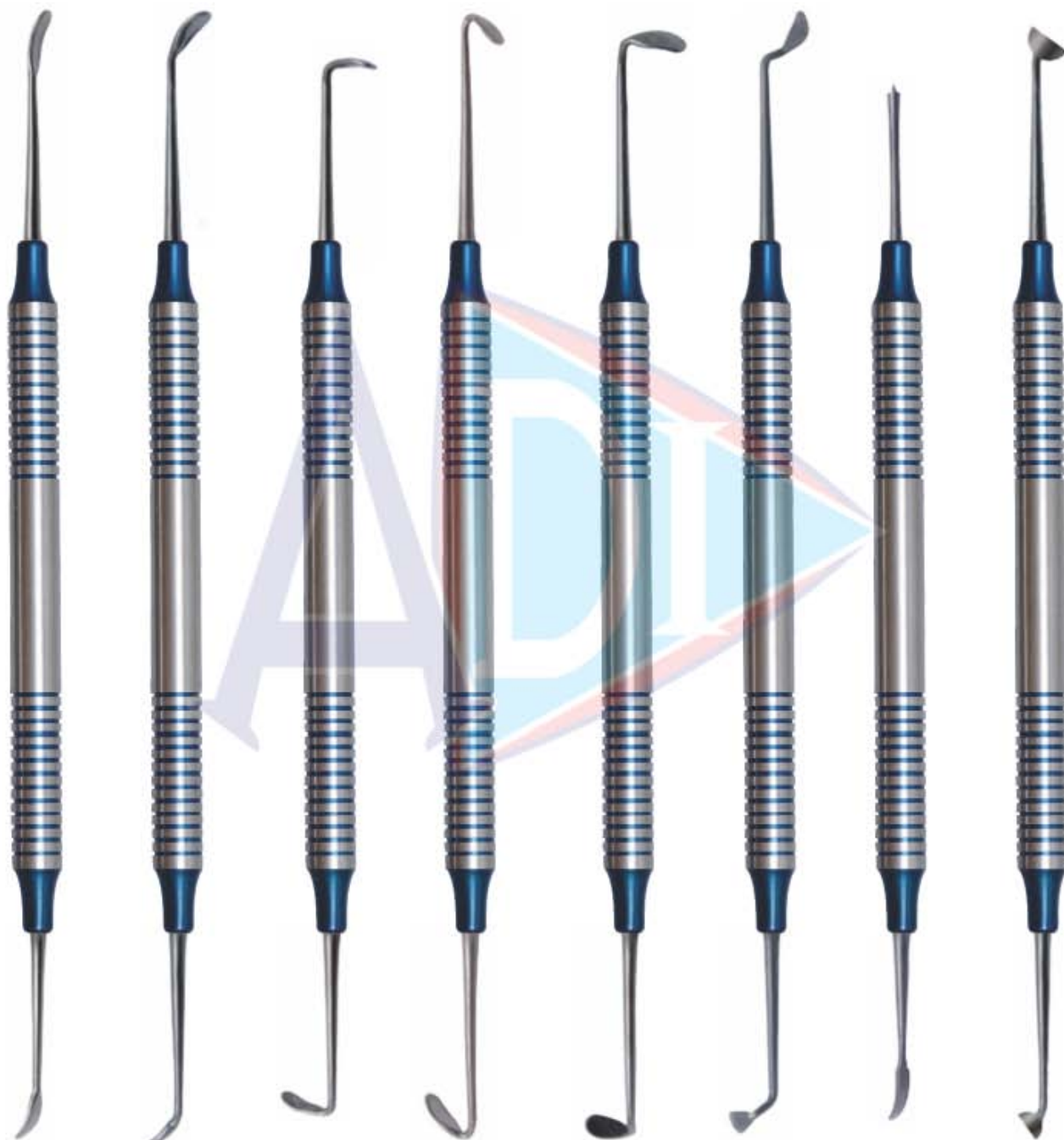

DE-2140
Sinuslift 1

DE-2141
Sinuslift 2

DE-2142
Sinuslift 3

DE-2143
Sinuslift 4

DE-2144
Sinuslift 5

DE-2145
Sinuslift 6

DE-2146
Membrane
3Positioning 1

DE-2147
Condenser 1

- Инструменты для имплантологии
 - Implantologie
 - Implantologie
- Инструменти для імплантології
 - Implantologia
 - زراعة الأسنان

Sinus Lift Instrument,
Flexible Sinus Lift instruments
reduce the risk of perforation of the
"Schneider's membrane"

Sinus Lift Elevator,
10 mm Straight grip
Length 175 mm, Sinus lift elevators, dull,
for gentle peeling and lifting the
Schneider membrane

Sinus lift instrument
10 mm Straight grip Length 180 mm,
Buser (B1, B2, B3) raspatories,
quality medical stainless steel,
corrosion-resistant

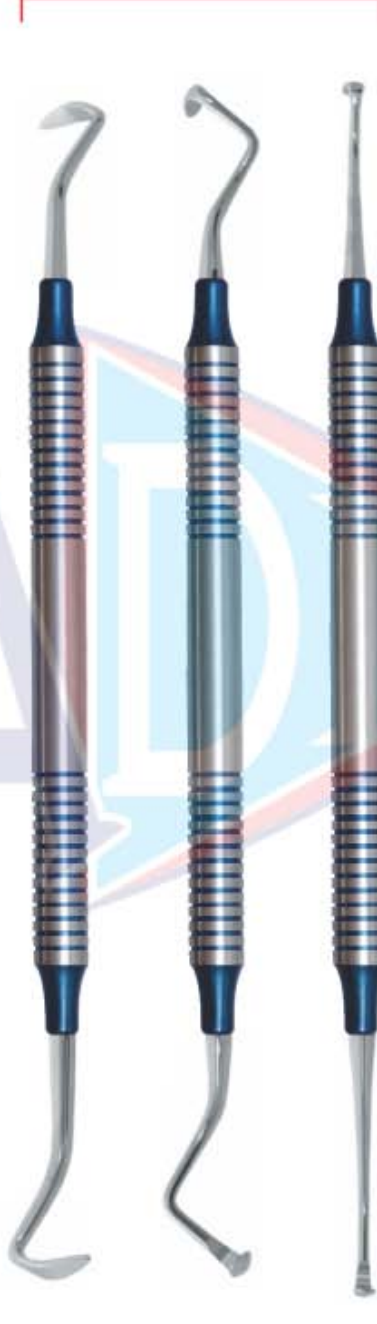

DE-2148
Fig. 1

DE-2149
Fig. 2

DE-2150
Fig. 3

DE-2151
Fig. 1

DE-2152
Fig. 2

DE-2153
Fig. 3

DE-2154
B01

DE-2155
B02

DE-2156
B03

IMPLANTOLOGY



- Инструменты для имплантологии
- Implantologie
- Implantologie
- Инструменти для имплантології
- Implantoloia
- زراعة الأسنان

Sinus lift instrument 10 mm Straight grip Sinus lift elevators, blunt or sharply curved (H01, H02, K03, K04, K78, K77)



DE-2157
Sinus lift instrument
H01



DE-2158
Sinus lift instrument
H02



DE-2159
Sinus lift instrument
K03



DE-2160
Sinus lift instrument
K04



DE-2161
Sinus lift instrument
K78



DE-2162
Sinus lift instrument
K77

- Инструменты для имплантологии
 - Implantologie
 - Implantologie
- Инструменти для імплантології
 - Implantologia
 - زراعة الأسنان

Composite Filling Instruments Set of 6 Pcs



DE-2163



DE-2164



DE-2165



DE-2166



DE-2167



DE-2168

COMPOSITE INSTRUMENTS USE:

A composite (tooth colored) filling is used to repair a tooth that is affected by decay, cracks, fractures, etc. The decayed or affected portion of the tooth will be removed and then filled with a composite filling.

There are many types of filling materials available, each with their own advantages and disadvantages. You and your dentist can discuss the best options for restoring your teeth. Composite fillings, along with silver amalgam fillings, are the most widely used today. Because composite fillings are tooth colored, they can be closely matched to the color of existing teeth, and are more aesthetically suited for use in front teeth or the more visible areas of the teeth.

As with most dental restorations, composite fillings are not permanent and may someday have to be replaced. They are very durable, and will last many years, giving you a long lasting, beautiful smile.

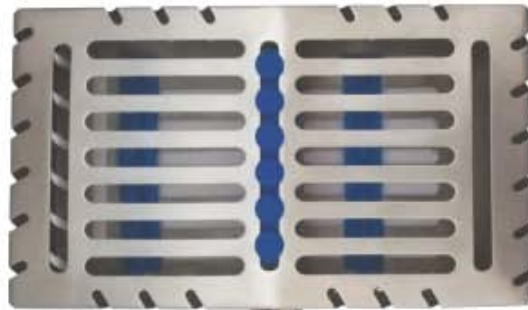

DE-2169

IMPLANTOLOGY



- Инструменты для имплантологии
- Implantologie
- Implantologie
- Инструменти для імплантології
- Implantoloia
- زراعة الأسنان

Set of 5 Composite Gold Tip Instruments
DE-2170



Set of 4 Composite Blue Tip Instruments
DE-2171



Set of 3 Composite Blue Tip Instruments
DE-2172



Set of 2 Composite Blue Tip Instruments
DE-2173



DE-2174 Periosteal Elevators Molt # 9

DE-2175 Endodontic explorer DG # 16



IMPLANTOLOGY

- Инструменты для имплантологии
- Implantologie
- Implantologie
- Инструменти для імплантології
- Implantologia
- زراعة الأسنان

VISTA TUNNELING INSTRUMENTS SET



DE-2176



DE-2177



DE-2178



DE-2179



DE-2180



DE-2181



DE-2182



IMPLANTOLOGY



- Инструменты для имплантологии
- Implantologie
- Implantologie

- Инструменти для імплантології
- Implantologia
- زراعة الأسنان



DE-2183
used for elevation of sinus membrane



DE-2184
used for elevation of sinus membrane



DE-2185
Cobra in / out (2-4-5-6-8-10mm)



DE-2186
Cobra 3.5mm



DE-2187
sinus 4.8 / 5.8 (2-4-5-6-8-10mm)



DE-2188
sinus 2.8 / 3.8 (2-4-5-6-8-10mm)



DE-2189
Bone Graft 3.8SP / 2.8mm (2-4-5-6-8-10mm)



DE-2190
Cobra in / out (2-4-5-6-8-10mm)



DE-2191
Cobra 3.5mm



DE-2192
Gold Color Set Dental Oral Implantology Sinus Set of 10 Pcs with cassette

IMPLANTOLOGY

- Инструменты для имплантологии
- Implantologie
- Implantologie
- Инструменти для імплантології
- Implantologia
- زراعة الأسنان



DE-2193
Sinus Lift elevator 1



DE-2194
Sinus Lift elevator 2



DE-2195
Sinus Lift elevator 3



DE-2196
Sinus Lift elevator 4



DE-2197
Sinus Lift elevator 5



DE-2198
Sinus Lift elevator 6



DE-2199
Sinus Lift Elevators Set of 7 Pcs
with cassette

IMPLANTOLOGY



- Инструменты для имплантологии
- Implantologie
- Implantologia
- زراعة الأسنان

Sinus Left Elevator Set of 10 Pcs

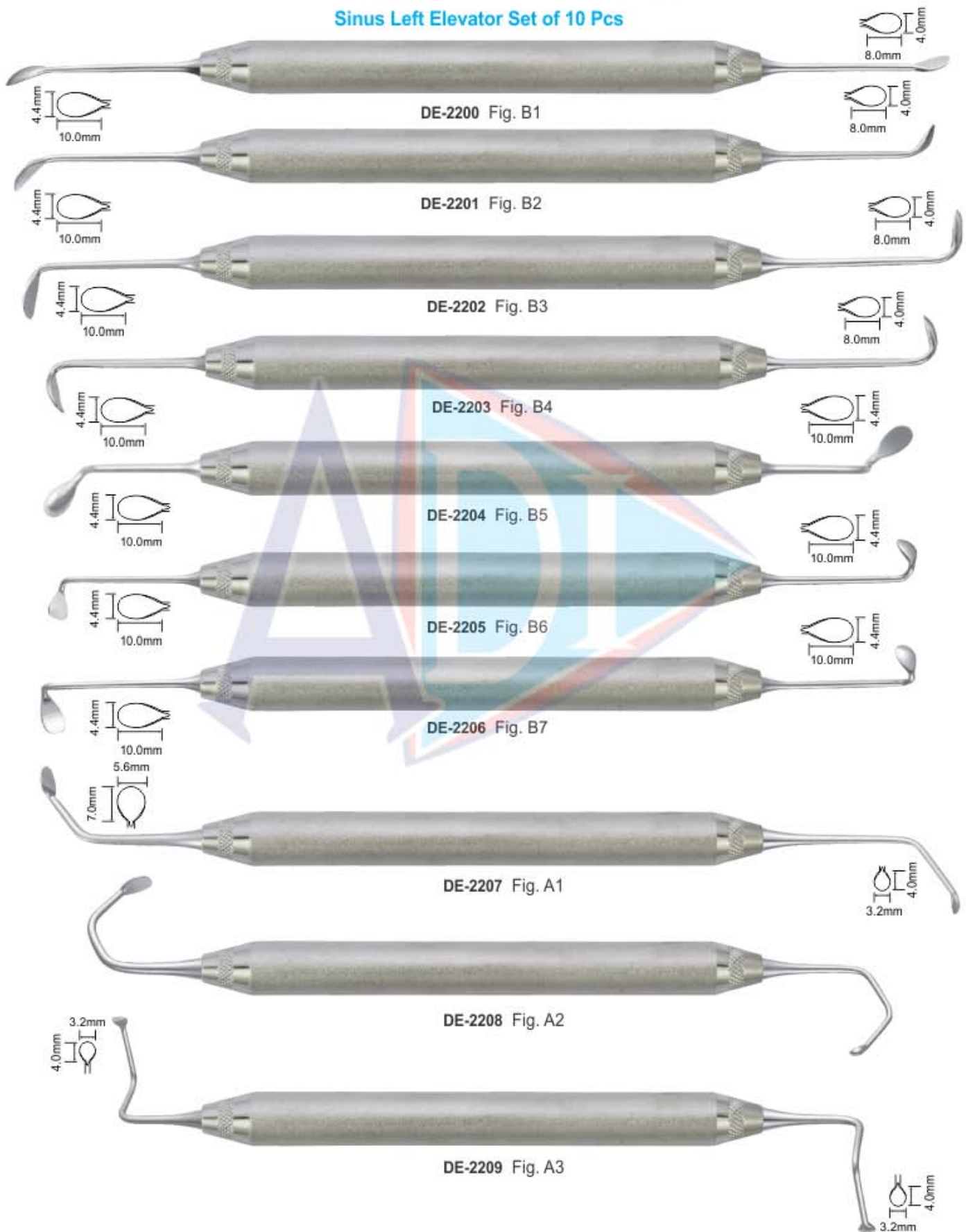

- Инструменты для имплантологии
 - Implantologie
 - Implantologie
- Инструменти для імплантології
 - Implantologia
 - زراعة الأسنان

Blue Titanium Coated Bone Grafting Instruments



DE-2216
Blue Titanium Coated Bone Grafting Instruments Set of 7 Pcs
with cassette

IMPLANTOLOGY



- Инструменты для имплантологии
- Implantologie
- Implantologie

- Инструменти для имплантології
- Implantoloia
- زراعة الأسنان



DE-2217
Fig. 1



With curette the sinus membrane is further detached over a broad area in the inner region, especially along the roof of the palate.



DE-2218
Fig. 2



DE-2219
Fig. 3



DE-2220
Fig. 4



DE-2221
Fig. 5



DE-2222
Fig. 6



DE-2223



DE-2224



DE-2225



DE-2226



DE-2227



Flexible Sinus-Lift Curettes – for an optimum sensitivity during the direct lift procedure

The perforation of the Schneiderian membrane is a complication that often occurs during a maxillary sinus floor augmentation procedure. The Sinus-Lift Instruments increase the sensitivity by blunt and flexible working tips with "Swing-Effect". Because of their special shapes and the characteristic of the stainless steel between the handle and the active part, light pressure is cushioned and gives the operator a direct and sensitive response. At the same time the risk to perforate the Schneiderian membrane is reduced to a minimum. Already at the development the focus was a practicable handling. Because of varying angulations and shapes of the active parts also in difficult areas they are easy to navigate also in difficult areas. The line of curettes consists of six different figures for every situation: They are complemented by spoon and condenser to place the bone graft.



The "Schneider's Membrane" of the sinus can be detached with curette by 1–2mm along the total cortical bone.



Curette is particularly useful in the lower part for detaching the membrane further. The same goes for the caudal area, especially when the membrane is 4–5 mm above the base of the maxillary sinus and the maxillary sinus is built up with granular material.



Curette makes it possible to lift the membrane further in mesial region. One working tip is especially designed for the right maxillary sinus and the other for the left maxillary sinus.



With curette the sinus membrane is further elevated in the upper and posterior part of the maxillary sinus wall.

- Инструменты для имплантологии
- Implantologie
- Implantologie
- Инструменти для імплантології
- Implantologia
- زراعة الأسنان

IMPLANT SINUS LIFT INSTRUMENTS HOLLOW HANDLE 9.5MM LENGTH 170MM

SINUS LIFT INSTRUMENTS HOLLOW HANDLE 9.5MM LENGTH 170MM

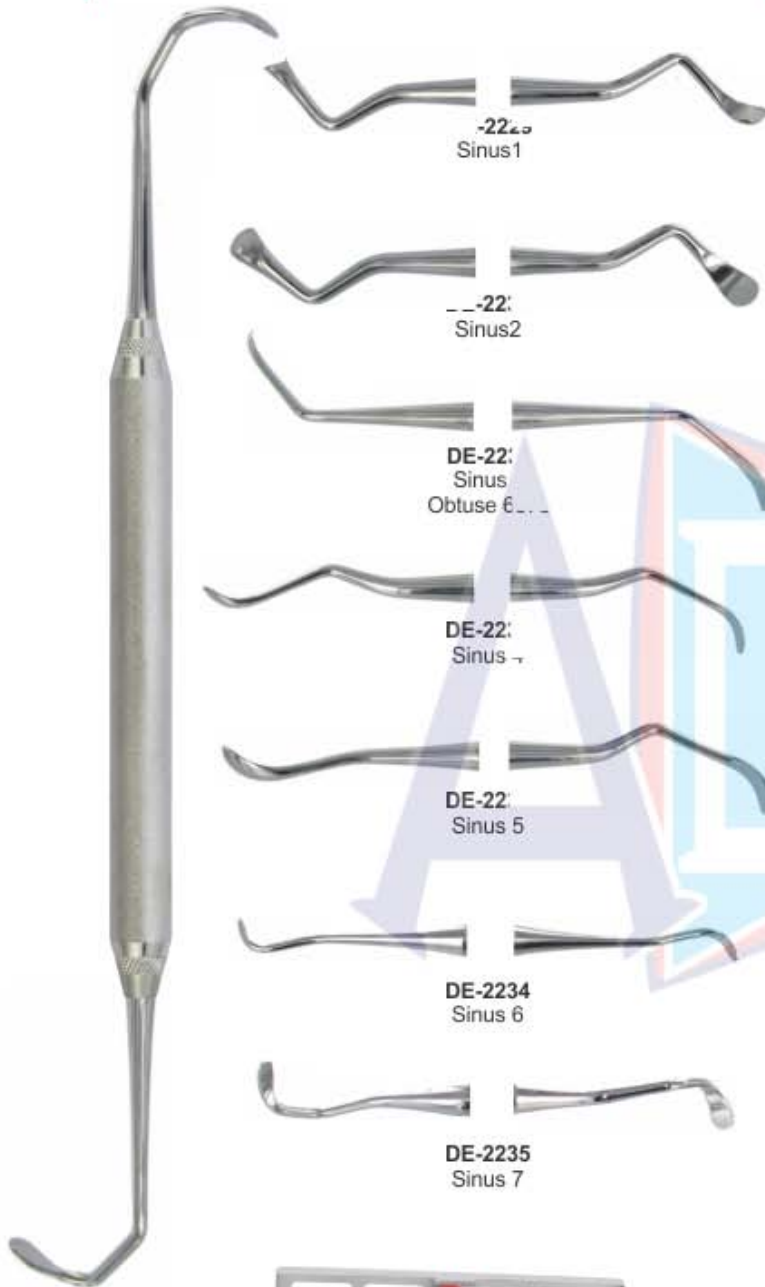

DE-2220
Sinus 1

DE-2221
Sinus 2

DE-2222
Sinus
Obtuse 6

DE-2223
Sinus 3

DE-2224
Sinus 5

DE-2234
Sinus 6

DE-2235
Sinus 7

DE-2228
Acute 6577

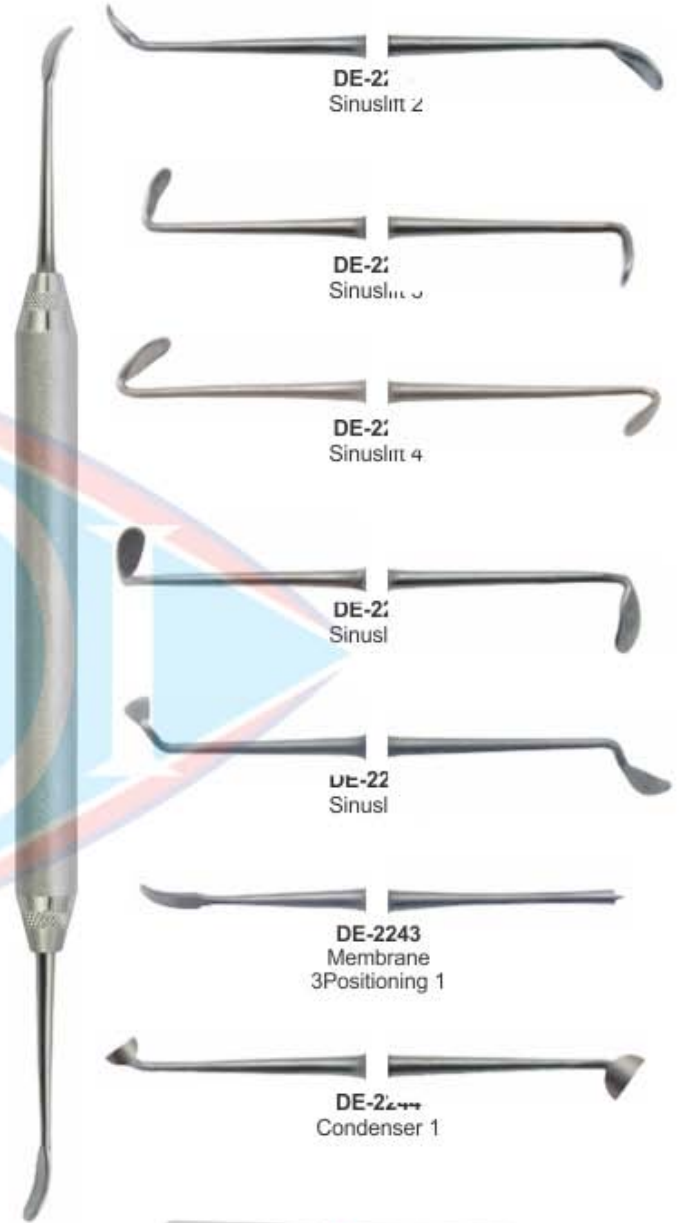

DE-2225
Sinuslift 2

DE-2226
Sinuslift 3

DE-2227
Sinuslift 4

DE-2228
Sinuslift

DE-2229
Sinuslift

DE-2243
Membrane
3Positioning 1

DE-2244
Condenser 1

DE-2237
Sinuslift 1



9 Pcs of Set
DE-2236



9 Pcs of Set
DE-2245

IMPLANTOLOGY



- Инструменты для имплантологии
- Implantologie
- Implantologie

- Инструменти для имплантології
- Implantoloia
- زراعة الأسنان

IMPLANT SINUS LIFT INSTRUMENTS PERIODONTAL SURGERY SURGICAL CHISELS KRAMER NEVINS SINUS LIFT

SURGICAL CHISELS



DE-2246
TG



DE-2247 SOLT3/4



3.5mm

DE-2254 13K/TG

3mm



DE-2248 TGO



3.5mm

DE-2255
13K/TG Titanium

3mm



DE-2249 OCH3



3.5mm

DE-2256 13K/TG

4.5mm



DE-2250 OCH4



3.5mm

DE-2257
13KL/R Titanium

4.5mm



DE-2251 FEDI1



4mm

DE-2258 13KL 4/6mm
Titanium Available

6mm



DE-2252 FEDI2



DE-2253 FEDI3



DE-2259
Cassette For Instruments



IMPLANTOLOGY

- Инструменты для имплантологии
- Implantologie
- Implantologie
- Инструменти для імплантології
- Implantologia
- زراعة الأسنان

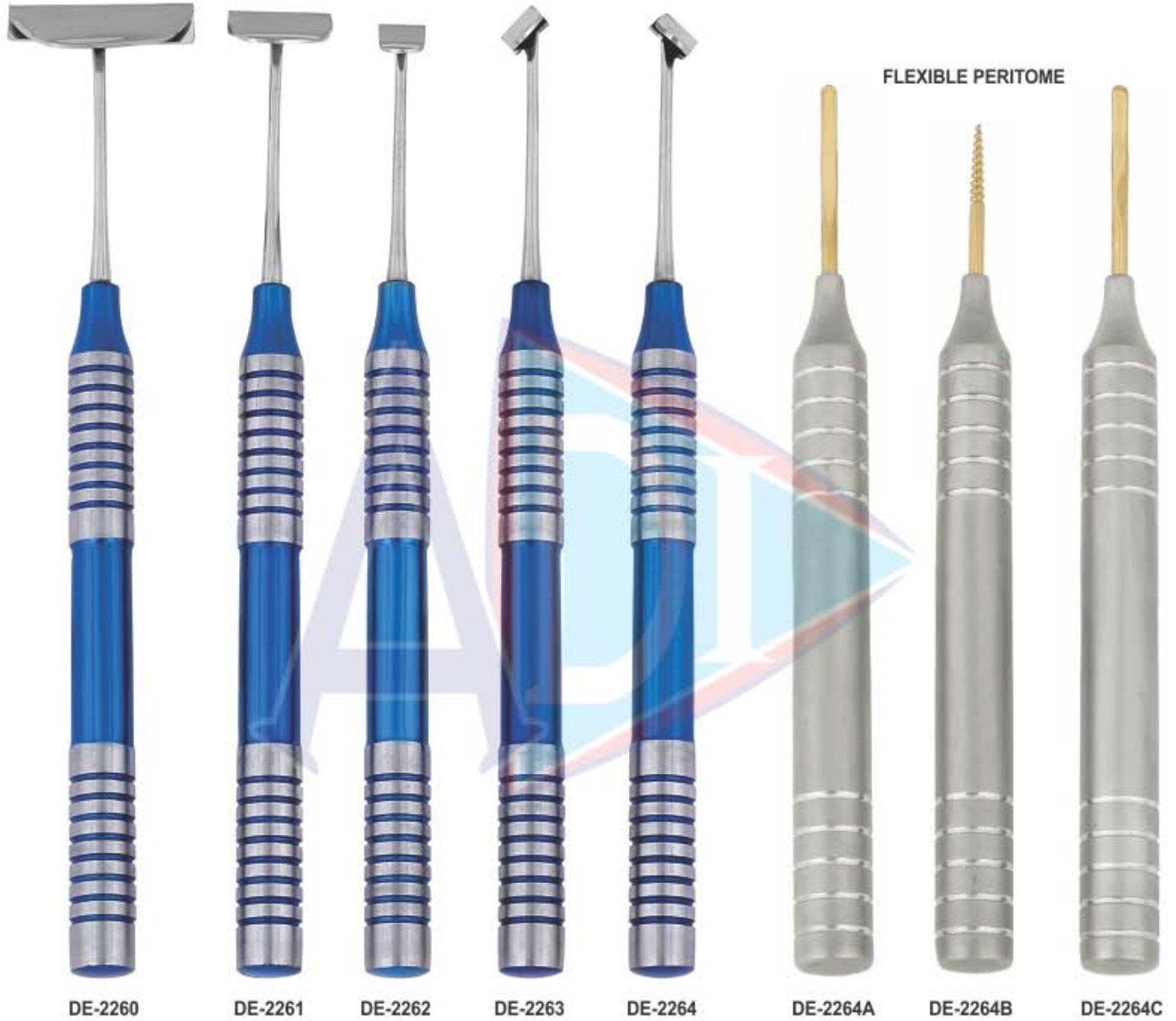

Soft Brushing Kit Set of 6 Pcs



IMPLANTOLOGY



- Инструменты для имплантологии
- Implantologie
- Implantologie

- Инструменти для имплантології
- Implantologia
- زراعة الأسنان

SINUS ELEVATOR & MEMBRANE LIFT TIPS



DE-2265
Membrane Detach Elevator



DE-2266
Membrane Elevator



DE-2267
Membrane Elevator



DE-2268
Membrane Elevator



DE-2269
Membrane Elevator



DE-2270
Bone Graft Packer



DE-2270A Pt2 Titanium
A/V Regular



DE-2270B Pt1 Titanium
A/V Regular



DE-2270C Pt3 Titanium Angel S/E



DE-2270D Pt4 Titanium STR S/E



DE-2270E Pt5 Titanium TG CVD S/E



DE-2271
Sinus Left Elevator & Membrane Lift Tips
set of 7 Pcs

- Инструменты для имплантологии
- Instrumentologie
- Implantologie
- Инструменти для имплантології
- Implantologia
- زراعة الأسنان

MIXING SPATULA WITH SHOVEL



DE-2272
Bone Carrier
Titanium



DE-2273
Raspator, Prichard
Length 180 mm,
10 mm hollow handle,
double-ended
10.5 mm | 4.5 mm,



DE-2274
Raspator, Prichard
Length 180 mm,
10 mm hollow handle,
double ended



DE-2275
Raspator, Prichard
Length 180 mm,
10 mm hollow handle,
double-ended
10.5 mm | 4.5 mm,



DE-2276
Mixing Spatula
with shovel
17cm



DE-2277
Mixing Spatula
with shovel
18.5cm



DE-2278
Graft Material Spoon
Concave Tip For
Larger Grafts

IMPLANTOLOGY



- Инструменты для имплантологии
 - Implantologie
 - Implantologie
- Инструменти для имплантології
 - Implantologia
 - زراعة الأسنان

BONE GRAFTING INSTRUMENTS COMPACTOR/TAMPERS

Product offering includes instruments for harvesting, mixing and compacting bone Provides clinicians with the proper instrumentation for bone grafting procedures Weighted bone basin Prevents tipping and spilling of bone and other materials during mixing



DE-2279
Graft Packer, Concave Tips DE 4/6mm



DE-2280
Bone Spoon/ Packer DE 3mm



DE-2281
Blade and pusher Length 180 mm, for straight or angled, blade: 15 x 5 mm, pusher: 4 mm diameter Straight



DE-2282
Blade and pusher Length 180 mm, for straight or angled, blade: 15 x 5 mm, pusher: 4 mm diameter angular



DE-2283
Spoon and pusher Length 180 mm, for angled spoon: 10 x 5 mm, pusher: diameter 3 mm



DE-2284
Graft Packer, Smooth Tips DE 5/8mm



DE-2285
Graft Packer, Serrated Tips DE 3/4mm



DE-2286
Graft Packer, Serrated Tips DE 6/8mm



DE-2287
Titanium graft packer/placement site depth gauge 3.3mm & 4.0mm Diameter tips Marked at 8, 11, 13, 15 & 18mm



DE-2288
Tamper Length 170 mm, for bone material, double-ended, diameter 3.2 mm (2-4-6-8-10) and diameter 2.5mm (2-4-6-8-10)

- Инструменты для имплантологии
 - Implantologie
 - Implantologie
- Інструменти для імплантології
 - Implantoloia
 - زراعة الأسنان

SPOON AND PUSHER (TRINOVO)

Trinovo handle, different workers, for bone material, high-grade medical stainless steel, corrosion-resistant



IMPLANTOLOGY



- Инструменты для имплантологии
- Implantologie
- Implantologie

- Инструменти для імплантології
- Implantoloia
- زراعة الأسنان

Hollow Handle 10mm Length 170mm



- Инструменты для имплантологии
 - Implantologie
 - Implantologie
- Инструменти для імплантології
 - Implantologia
 - زراعة الأسنان

TISSUE MEMBRANE FORCEPS



DE-2305
Tissue Graft Forcep
Serrated Teeth



DE-2306
Self Locking
Grooved



DE-2307
Tissue Graft Forcep
Serrated Teeth



DE-2308
Titanium
Locking Plier



DE-2309
TC Gripper Carbide
Tipped Tissue Forceps
Serrated Carbide Tips
14.5cm



DE-2310
Adson Carbide
Tipped Tissue Forceps
Serrated Carbide Tips
12cm



DE-2311
Micor Adson 1x2
Tissue Forcep 12.1cm
1x2 Teeth - 0.5mm Tips



DE-2312
Adson 7x7
Tissue Forceps
7x7 Teeth 12cm



DE-2313
Adson 7x7 Curved
Tissue Forceps
7x7 Teeth 12cm



DE-2314
Suture Pliers
Suture Forceps with
1.6mm Ring Tip



DE-2315
Debakey Atraumatic
Tissue Forceps Straight
Serrated Teeth
16cm



DE-2316
Debakey Atraumatic
Tissue Forceps Curved
Serrated Teeth
16cm

IMPLANTOLOGY



- Инструменты для имплантологии
- Implantologie
- Implants
- زراعة الأسنان

TISSUE MEMBRANE FORCEPS



DE-2317
Russian Long
Tissue Forceps
Serrated Tip
20cm



DE-2318
Russian
Tissue Forceps
Serrated Tip
15cm



DE-2319
Tissue Punch Forceps
To Remove Tissue
After Using Punch



DE-2320
13.5 cm
narrow



DE-2321
10.5 cm

Membrane tweezers KUEHNE



DE-2322
13.5 cm
wide



DE-2323
Pin-Tweezers
with or without lock,
length 15 cm,
with lock



DE-2324
without lock



DE-2325
Haltepinzette with lock
15,5 cm, for pins, towards
the tips, etc



DE-2326
Carry Forceps
15cm



DE-2327
Carry Forceps
15cm



DE-2328
Carry Forceps
15cm

- Инструменты для имплантологии
- Implantologie
- Implantologie
- Инструменти для імплантології
- Implantologia
- زراعة الأسنان

OSTEOTOME CONVEXES / CONCAVE / CONIQUES

CONVEXES



DE-2329
SET OF 5 PIECES

CONCAVES

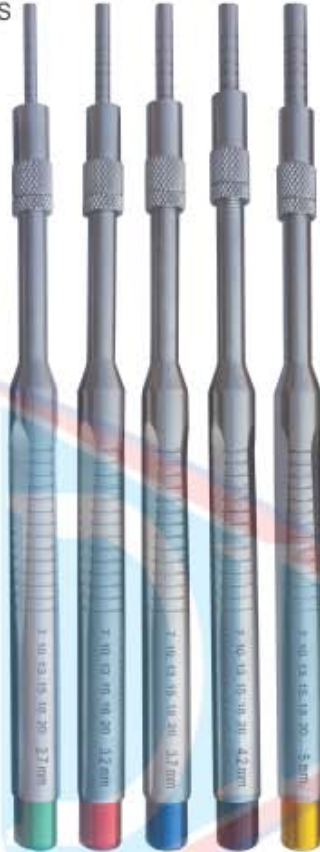

DE-2330
SET OF 5 PIECES

CONIQUES



DE-2331
SET OF 5 PIECES

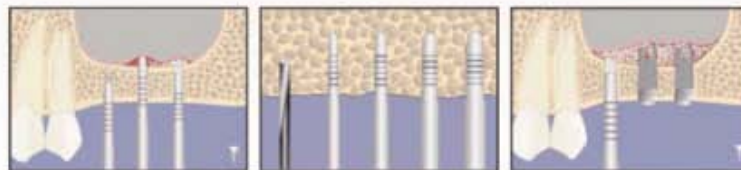

	CONVEXES STRAIGHT	DE-2329	2,7 Ømm	3,2 Ømm	3,7 Ømm	4,2 Ømm	5 Ømm
	CONCAVES STRAIGHT	DE-2330	2,7 Ømm	3,2 Ømm	3,7 Ømm	4,2 Ømm	5 Ømm
	CONIQUES STRAIGHT	DE-2331	2,7 Ømm	3,2 Ømm	3,7 Ømm	4,2 Ømm	5 Ømm

IMPLANTOLOGY



- Инструменты для имплантологии
- Implantologie
- Implantologia
- زراعة الأسنان

OSTEOTOME CONVEXES / CONCAVE / CONIQUES

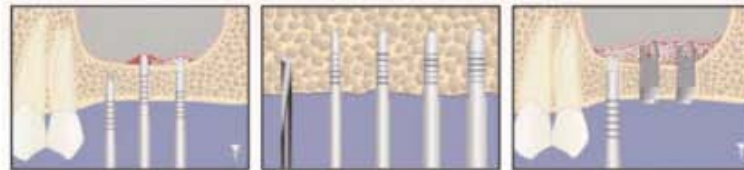
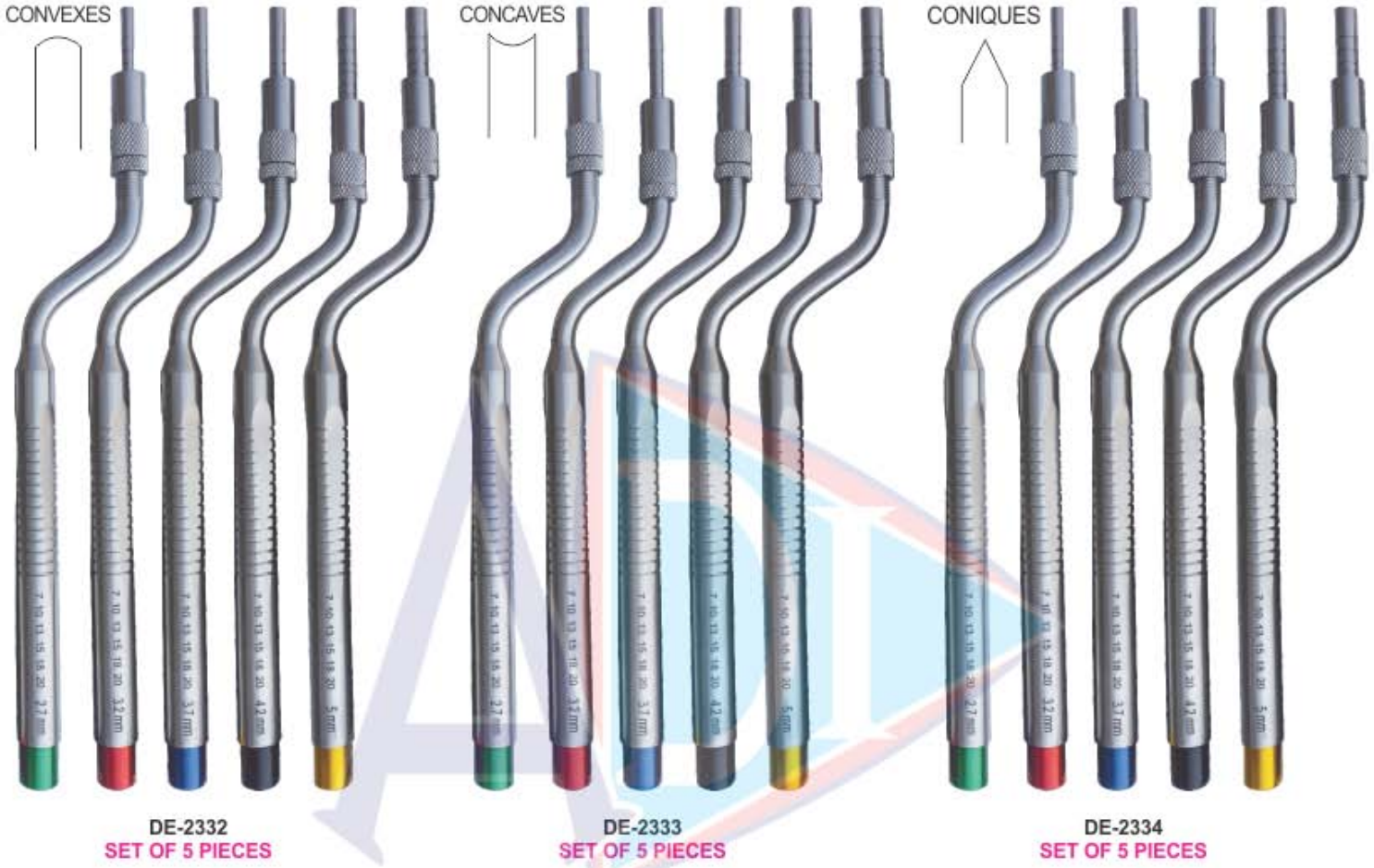

	CONVEXES CURVED	DE-2332	2,7 Ømm	3,2 Ømm	3,7 Ømm	4,2 Ømm	5 Ømm
	CONCAVES CURVED	DE-2333	2,7 Ømm	3,2 Ømm	3,7 Ømm	4,2 Ømm	5 Ømm
	CONIQUES CURVED	DE-2334	2,7 Ømm	3,2 Ømm	3,7 Ømm	4,2 Ømm	5 Ømm

- Инструменты для имплантологии
- Implantologie
- Implantologie
- Инструменти для імплантології
- Implantologia
- زراعة الأسنان

BONE SCRAPER STRAIGHT & CURVED



DE-2335
Bone Scraper
Straight

DE-2336
Bone Scraper
Curved

TISSUE PUNCH STRAIGHT & CURVED



Tissue Punch
Straight

Tissue Punch
Curved

Ø4.0 Ø5.0 Ø6.0 Ø7.0



DE-2349
Tissue Punch with pin
Set of Four Pieces



DE-2350
Tissue Punch
Set of Five Pieces



DE-2351
Tissue Punch
Set of Five Pieces

IMPLANTOLOGY



- Инструменты для имплантологии
- Implantologie
- Implantologie
- Инструменти для имплантології
- Implantologia
- زراعة الأسنان

BONE MILL BONE WELL

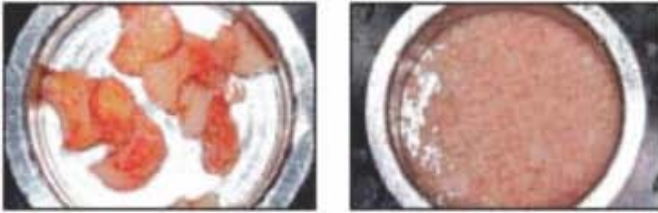

- Инструменты для имплантологии
- Implantologie
- Implantologie
- Инструменти для імплантології
- Implantologia
- زراعة الأسنان

TREPHINE

Burs with depth markings are suited for precise and simple transplantation of cylindrical bone grafts as well as for all other bone-extraction tasks.



DE-2367
Trepine Drill
Set of Eight Pieces



DE-2368
Trepine Drill
Set of Eight Pieces

BONE INJECTORS, COLLECTORS & SUCTION TUBE

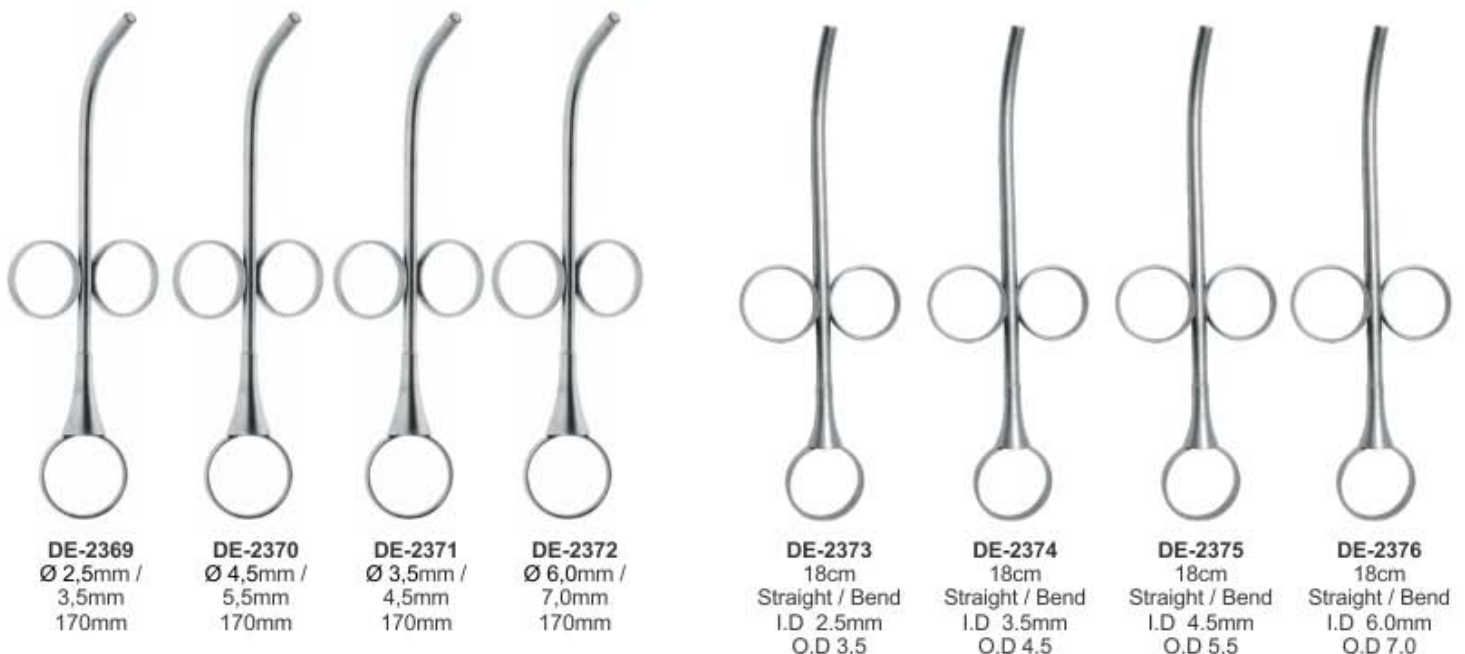

IMPLANTOLOGY



- Инструменты для имплантологии
- Implantologie
- Implants
- زراعة الأسنان

BONE EXPANDER SCREW & SURGICAL KITS



Ø2.0mm Ø2.5mm Ø2.8mm
DE-2377 Short Implant Drills

Ø3.2mm Ø3.65mm Ø4.2mm Ø5.2mm
DE-2378 Long Implant Drills



DE-2379
Bone Universal Kit
Drill: 2mm, 2.8mm, 3.2mm, 3.65mm, 4.2mm, 4.5mm, 4.8mm, 5.2mm
Trepines Bit: 3.0mm, 4.0mm, 5.0mm, 6.0mm, 7.0mm, 8.0mm, 9.0mm, 10mm.
Driver: 2.5mm, 2.5mm Hand Pcs, 1.25mm, 1.25mm Hand Pcs
Short Driver 2.5mm, Long Driver 2.5mm
1.25mm, Short Hex Driver Hand Pcs
1.25mm, Long Hex Driver Hand Pcs, Torque Wrench 4.0mm



DE-2380
Bone Expander Kit
Expander: 2.6mm, 3.0mm, 3.4mm, 3.8mm, 4.3mm
Ratchet Driver, Parallel Pin
Pilot Drill, Drill 1.4mm, Drill Driver 4mm
Hand Driver 4mm, Ratchet 4.0mm



DE-2381
Bone Universal Kit
Drill: 2mm, 2.8mm, 3.2mm, 3.65mm, 4.2mm, 4.5mm, 4.8mm, 5.2mm
Trepines Bit:
3.0mm, 4.0mm, 5.0mm, 6.0mm, 7.0mm, 8.0mm, 9.0mm, 10mm.

Bone Compression:
2mm, 3.3mm, 2.8mm, 4.2mm, 3mm, 3.5mm
Driver:
2.5mm, 2.5mm Hand Pcs
1.25mm, 1.25mm Hand Pcs
Short Driver 2.5mm
Long Driver 2.5mm
1.25mm, Short Hex Driver Hand Pcs
1.25mm, Long Hex Driver Hand Pcs
Torque Wrench 6.35mm 1 Pcs



DE-2382
Conical Drills: 20 Pcs
Tissue Punches:
3.0mm, 3.50mm, 4.0mm, 4.5mm, 5.0mm, 6.0mm, 6.50mm
Bone Expander:
1.6/3.8mm, 1.9/3.0mm, 2.1/3.6mm, 2.6/3.8mm, 2.9/4.3mm
Drill Adapter: 1 Pcs
1.25mm, 2.50mm Hex Driver Hand Pcs

Pilot Drill: 1.6mm
Drill Bit: 1.4mm, 1.6mm, 1.8mm, 2.0mm, 2.2mm
Ratchet Driver: 4mm/6.35, 1.25/2.50
Rimer: 3.2/4.7mm, 3.7/4.7mm
Parallel Pin: 4.5mm, 2.5mm
Double step Drill: 2.4/2.8mm
Depth Gauge: 1 Pcs
Torque Wrench 6.35mm Universal: 1 Pcs

- Инструменты для имплантологии
 - Implantologie
 - Implantologie
- Инструменти для імплантології
 - Implantologia
 - زراعة الأسنان

KEYS FOR IMPLANT SCREW



DE-2383



DE-2384



DE-2385



DE-2386

TORQUE WRENCH & RATCHET



DE-2387 Star Torque Wrench 6.35mm Universal



DE-2388 Round Torque Wrench 4.0mm Universal



DE-2389 Hex Driver With 4.0mm Driver



DE-2390 Star Torque Wrench 6.35mm Universal



DE-2391 Hex Torque Wrench 4.00mm Universal



DE-2392 Star Torque Wrench 6.35mm Universal



DE-2393 Star Torque Wrench 6.35mm Universal



DE-2394 Star Torque Wrench 6.35mm Universal



DE-2395 Star Torque Wrench 6.35mm Universal



DE-2396 Star Torque Wrench 6.35mm Universal



DE-2397 Star Ratchet Wrench 6.35mm Universal



DE-2398 Star Ratchet Wrench 6.35mm Universal



DE-2399 Star Ratchet Wrench 6.35mm Universal



DE-2400 Star Ratchet Wrench 4.0mm Universal



DE-2401 Round Ratchet Wrench 4.0mm Universal



DE-2402 Round Ratchet Wrench 3.35mm Universal



DE-2403 Star Ratchet Wrench 4.0mm Universal



DE-2404 Star Ratchet Wrench 6.35mm Universal

IMPLANTOLOGY



- Инструменты для имплантологии
- Implantologie
- Implantologia

- Инструменти для імплантології
- Implantologia
- زراعة الأسنان



DE-2405
Suction Cannula Kit
with 3 Needles



Suction Pipe



Suction Needle
1mm



Suction Needle
1.5mm



Suction Needle
2mm



DE-2406
17.5cm

DE-2407
18cm

DE-2408
coarse
Ø 5mm

Suction tubes
to collect
the extracted
bone material
180mm



DE-2409
fine
Ø 9mm



DE-2410
Suction
Tubes
180mm

DE-2411
Suction
Tubes
180mm

DE-2412
Suction
Tubes
180mm



DE-2413
Fig. 6FR
Frazier
15 cm - Ø 2 mm

DE-2414
Ø 3 mm
length 180mm
DE-2415
Ø 4 mm
length 180mm
DE-2416
Ø 5 mm
length 180mm

IMPRESSION TRAYS

- Оттисковые ложки
- Porte-empreinte
- Abdrucklöffel
- Відбиткові ложки
- Cubetas para impresiones
- صواني الاطباع

PERFORATED WITH RIM LOCK

Set of 06 Pcs

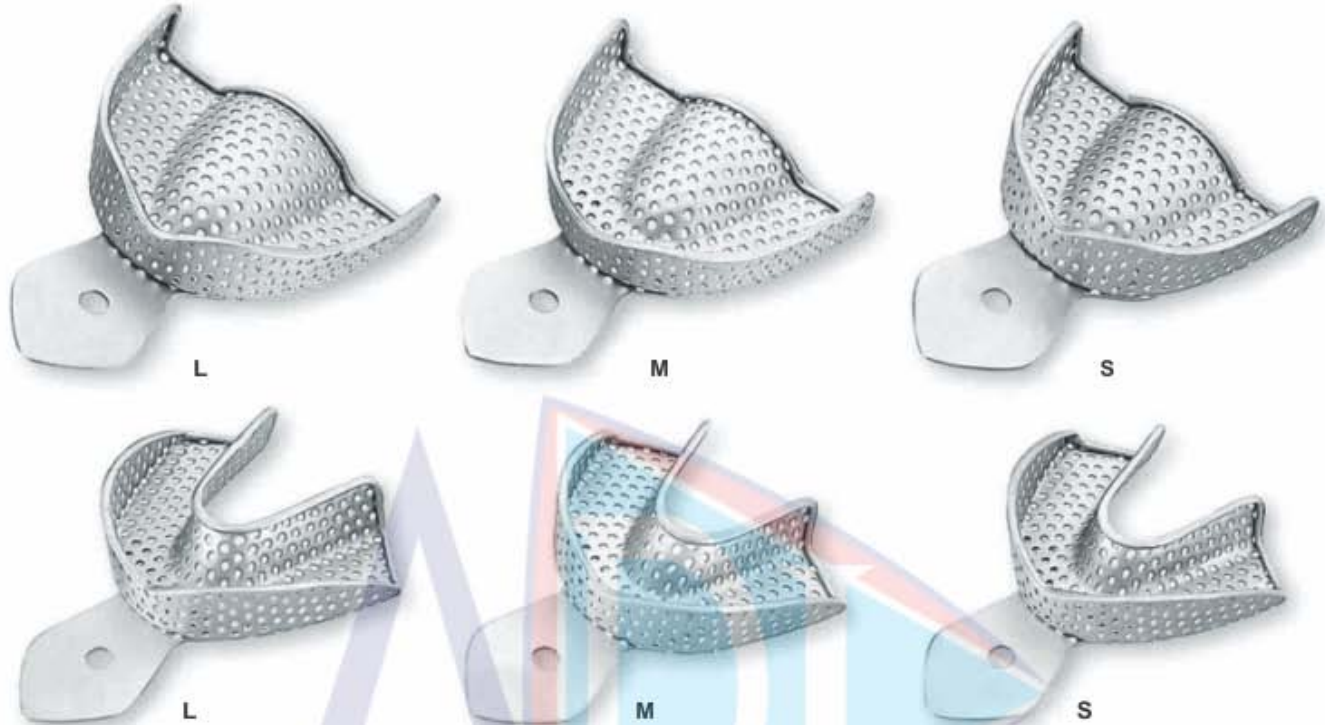

DE-2417 SET OF 06 PCS

Upper: S, M, L
Lower: S, M, L

PERFORATED WITH RIM LOCK

Set of 8 Pcs

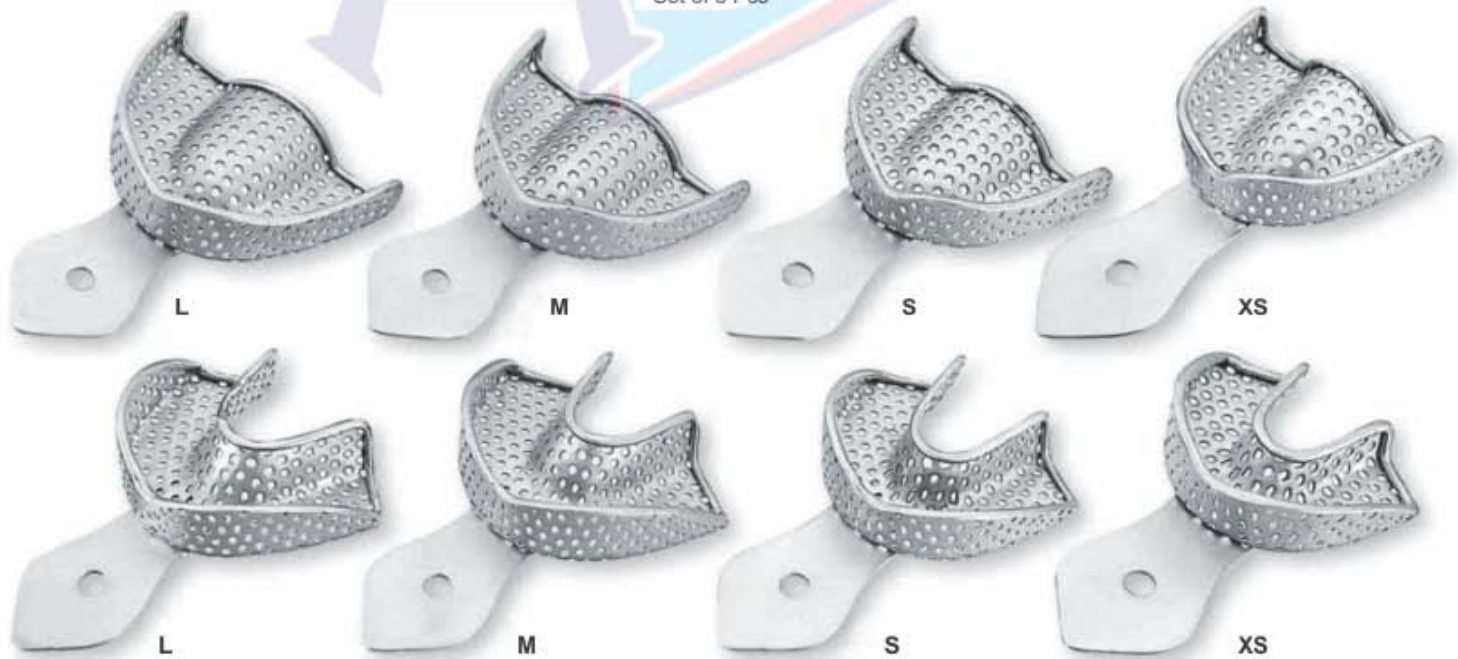

DE-2418 SET OF 08 PCS

Upper: XS, S, M, L
Lower: XS, S, M, L

DE-2419 SET OF 08 PCS

Upper: S, M, L, XL
Lower: S, M, L, XL

DE-2420 SET OF 10 PCS

Upper: XS, S, M, L, XL
Lower: XS, S, M, L, XL

IMPRESSION TRAYS



- Оттисные ложки
- Porte-empreinte
- Abdrucklöffel

- Відбиткові ложки
- Cubetas para impresiones
- صواني الانطباع

SOLID WITH RIM LOCK

Set of 6 Pcs

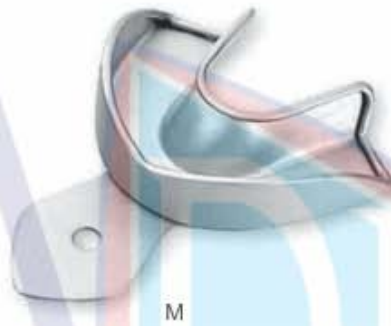

DE-2421 SET OF 06 PCS
Upper: S, M, L
Lower: S, M, L

SOLID WITH RIM LOCK

Set of 8 Pcs



DE-2422 SET OF 08 PCS
Upper: XS, S, M, L
Lower: XS, S, M, L

DE-2423 SET OF 08 PCS
Upper: S, M, L, XL
Lower: S, M, L, XL

DE-2424 SET OF 10 PCS
Upper: XS, S, M, L, XL
Lower: XS, S, M, L, XL

IMPRESSION TRAYS

- Оттисные ложки
- Porte-empreinte
- Abdrucklöffel
- Відбиткові ложки
- Cubetas para impresiones
- صواني الاطباع

PERFORATED FULL DENTURE

Set of 8 Pcs

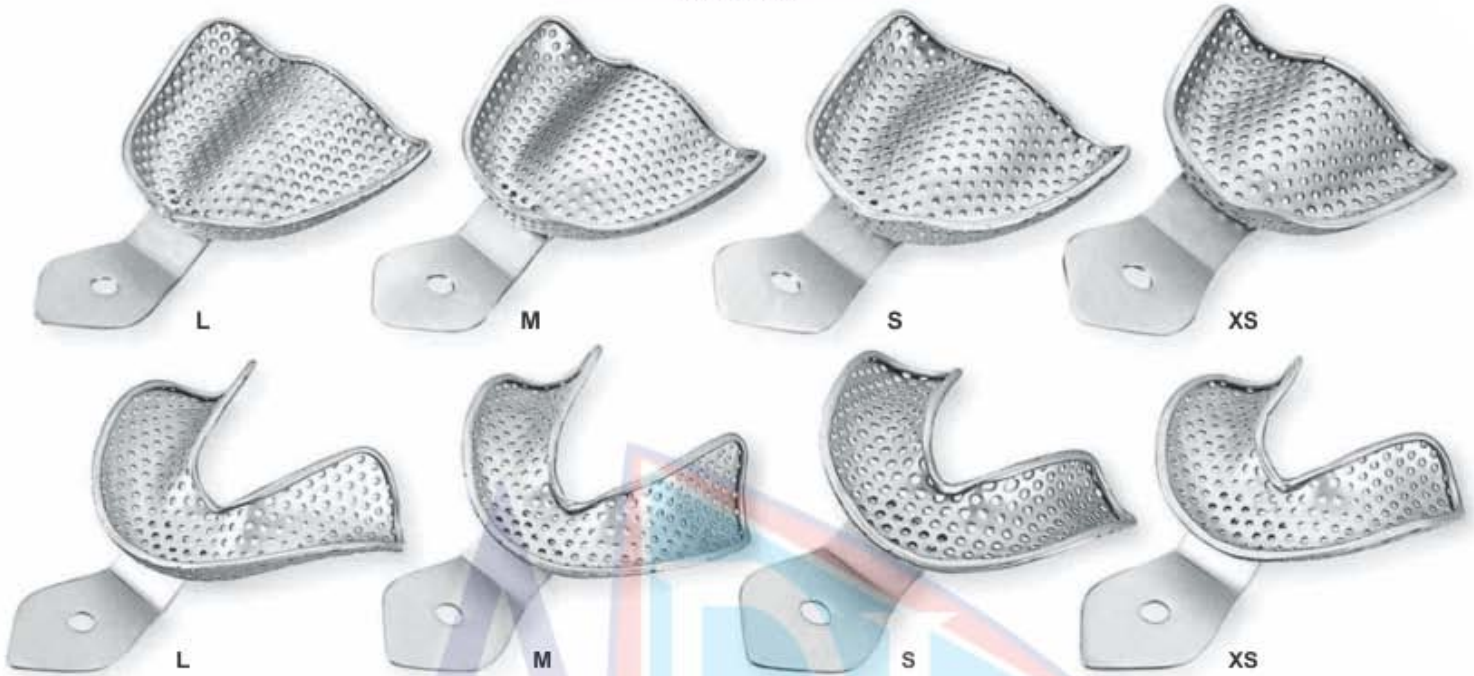

DE-2425 SET OF 08 PCS
Upper: S, M, L, XL
Lower: S, M, L, XL

DE-2426 SET OF 08 PCS
Upper: S, M, L
Lower: S, M, L

SOLID FULL DENTURE

Set of 8 Pcs



DE-2427 SET OF 08 PCS
Upper: S, M, L, XL
Lower: S, M, L, XL

DE-2428 SET OF 06 PCS
Upper: S, M, L
Lower: S, M, L

IMPRESSION TRAYS



- Оттисные ложки
- Porte-empreinte
- Abdrucklöffel
- Відбиткові ложки
- Cubetas para impresiones
- صواني الاتطباع

Perforated Without Rim Lock

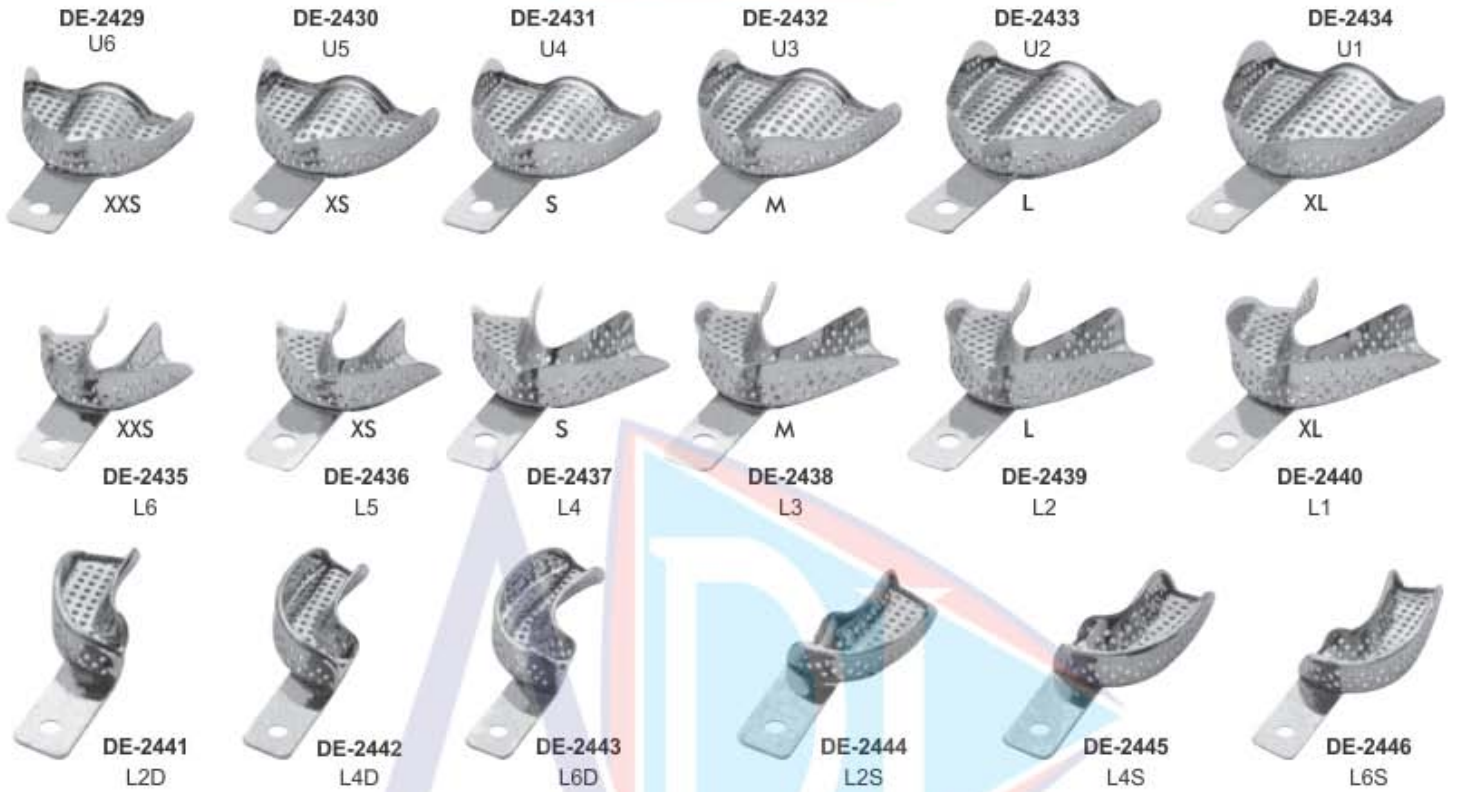

Solid With Rim Lock

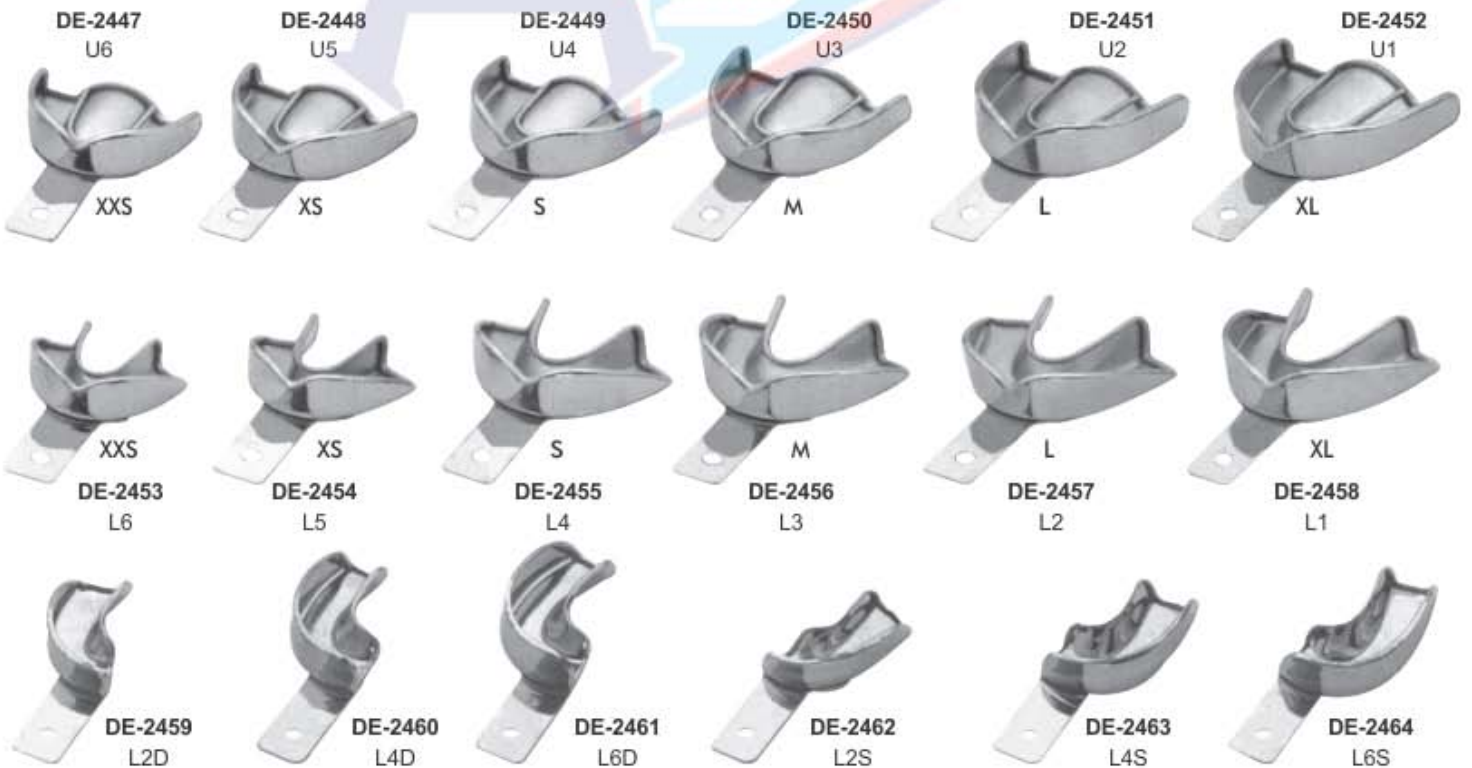



HOLLOWWARE INSTRUMENTS





Scalers Tray
DE-2500 200 x 100 mm



Scalers Trays
DE-2501 205 x 115 x 17 mm
DE-2502 205 x 152 x 17 mm
DE-2503 290 x 115 x 17 mm



Instruments Trays
DE-2504 200 x 110 x 30 mm
DE-2505 215 x 115 x 35 mm
DE-2506 220 x 130 x 30 mm
DE-2507 230 x 125 x 35 mm
DE-2508 245 x 140 x 40 mm
DE-2509 285 x 160 x 45 mm
DE-2510 315 x 175 x 50 mm
DE-2511 330 x 185 x 50 mm



Instruments Trays
DE-2512 150 x 100 x 50 mm
DE-2513 200 x 100 x 50 mm
DE-2514 220 x 120 x 50 mm
DE-2515 240 x 140 x 50 mm
DE-2516 200 x 150 x 50 mm
DE-2517 250 x 200 x 50 mm
DE-2518 300 x 250 x 50 mm
DE-2519 300 x 200 x 50 mm
DE-2520 350 x 250 x 50 mm
DE-2521 400 x 300 x 50 mm
DE-2522 450 x 300 x 50 mm
DE-2523 450 x 350 x 50 mm



Instruments Trays With Lid
DE-2524 150 x 100 x 50 mm
DE-2525 200 x 100 x 50 mm
DE-2526 220 x 120 x 50 mm
DE-2527 240 x 140 x 50 mm
DE-2528 200 x 150 x 50 mm
DE-2529 250 x 200 x 50 mm
DE-2530 300 x 250 x 50 mm
DE-2531 300 x 200 x 50 mm
DE-2532 350 x 250 x 50 mm
DE-2533 400 x 300 x 50 mm
DE-2534 450 x 300 x 50 mm
DE-2535 450 x 350 x 50 mm



Mayo Tray Perforated
DE-2536 150 x 100 x 25 mm
DE-2537 200 x 100 x 25 mm
DE-2538 220 x 120 x 25 mm
DE-2539 240 x 140 x 25 mm
DE-2540 200 x 150 x 25 mm
DE-2541 250 x 200 x 25 mm
DE-2542 300 x 250 x 25 mm
DE-2543 300 x 200 x 25 mm
DE-2544 350 x 250 x 25 mm
DE-2545 400 x 300 x 25 mm
DE-2546 450 x 300 x 25 mm
DE-2547 450 x 350 x 25 mm



Scaler Tray
DE-2548 200 x 115 mm
DE-2549 205 x 150 mm
DE-2550 290 x 150 mm
DE-2551 300 x 200 mm



Instruments Tray Perforated
DE-2552 150 x 100 x 50 mm
DE-2553 200 x 100 x 50 mm
DE-2554 220 x 120 x 50 mm
DE-2555 240 x 140 x 50 mm
DE-2556 200 x 150 x 50 mm
DE-2557 250 x 200 x 50 mm
DE-2558 300 x 250 x 50 mm
DE-2559 300 x 200 x 50 mm
DE-2560 350 x 250 x 50 mm
DE-2561 400 x 300 x 50 mm
DE-2562 450 x 300 x 50 mm
DE-2563 450 x 350 x 50 mm

Sterilizing boxes & instruments Trays



Instruments Box with Hooks
DE-2564 170 x 70 x 30 mm
DE-2565 180 x 80 x 40 mm
DE-2566 200 x 100 x 40 mm
DE-2567 200 x 100 x 50 mm
DE-2568 220 x 120 x 50 mm
DE-2569 250 x 150 x 50 mm
DE-2570 250 x 200 x 50 mm
DE-2571 300 x 150 x 60 mm
DE-2572 300 x 200 x 50 mm
DE-2573 350 x 250 x 50 mm
DE-2574 400 x 200 x 100 mm
DE-2575 450 x 250 x 50 mm



Instruments Box
DE-2576 170 x 70 x 30 mm
DE-2577 180 x 80 x 40 mm
DE-2578 200 x 100 x 40 mm
DE-2579 200 x 100 x 50 mm
DE-2580 220 x 120 x 50 mm
DE-2581 250 x 150 x 50 mm
DE-2582 250 x 200 x 50 mm
DE-2583 300 x 150 x 60 mm
DE-2584 300 x 200 x 50 mm
DE-2585 350 x 250 x 50 mm
DE-2586 400 x 200 x 100 mm
DE-2587 450 x 250 x 50 mm



Instruments Box Perforated
DE-2588 170 x 70 x 30 mm
DE-2589 180 x 80 x 40 mm
DE-2590 200 x 100 x 40 mm
DE-2591 200 x 100 x 50 mm
DE-2592 220 x 120 x 50 mm
DE-2593 250 x 150 x 50 mm
DE-2594 250 x 200 x 50 mm
DE-2595 300 x 150 x 60 mm
DE-2596 300 x 200 x 50 mm
DE-2597 350 x 250 x 50 mm
DE-2598 400 x 200 x 100 mm
DE-2599 450 x 250 x 50 mm



Gloves Box
DE-2600 300 x 150 mm



Catheters Tray with lid
DE-2601 200 x 60 x 40 mm
DE-2602 200 x 90 x 40 mm
DE-2603 320 x 95 x 50 mm
DE-2604 328 x 90 x 50 mm
DE-2605 365 x 90 x 50 mm
DE-2606 440 x 115 x 50 mm



Box With Filter
DE-2607 100 x 50 mm
DE-2608 250 x 150 mm
DE-2609 150 x 65 mm
DE-2610 200 x 100 mm
DE-2611 300 x 200 mm



Instruments Trays With Cover
DE-2612 210 x 110 x 50 mm
DE-2613 240 x 160 x 50 mm
DE-2614 300 x 180 x 50 mm
DE-2615 360 x 210 x 50 mm
DE-2616 400 x 230 x 55 mm

Instruments Trays Without Cover
DE-2617 210 x 110 x 50 mm
DE-2618 240 x 160 x 50 mm
DE-2619 300 x 180 x 50 mm
DE-2620 360 x 210 x 50 mm
DE-2621 400 x 230 x 55 mm



Instruments Box with lid
DE-2622 170 x 70 x 30 mm
DE-2623 180 x 80 x 40 mm
DE-2624 200 x 100 x 40 mm
DE-2625 200 x 100 x 50 mm
DE-2626 220 x 120 x 50 mm
DE-2627 250 x 150 x 50 mm
DE-2628 250 x 200 x 50 mm
DE-2629 300 x 150 x 60 mm
DE-2630 300 x 200 x 50 mm
DE-2631 350 x 250 x 50 mm
DE-2632 400 x 200 x 100 mm
DE-2633 450 x 250 x 50 mm



Kidney Tray
 DE-2634 160 mm
 DE-2635 200 mm
 DE-2636 250 mm
 DE-2637 280 mm
 DE-2638 300 mm



Kidney Tray Shallow
 DE-2639 170 mm
 DE-2640 220 mm
 DE-2641 240 mm



Kidney Tray With Cover
 DE-2642 160 mm
 DE-2643 200 mm
 DE-2644 250 mm
 DE-2645 280 mm
 DE-2646 300 mm



Kidney Tray
 DE-2647 160 mm
 DE-2648 200 mm
 DE-2649 250 mm
 DE-2650 280 mm
 DE-2651 300 mm



Forceps Jars
 DE-2652 30 x 90 mm
 DE-2653 50 x 100 mm
 DE-2654 50 x 130 mm
 DE-2655 50 x 175 mm
 DE-2656 75 x 100 mm
 DE-2657 75 x 130 mm
 DE-2658 75 x 175 mm
 DE-2659 100 x 175 mm
 DE-2660 100 x 200 mm



Methot Jar Without Lid
 DE-2661



Dressing Jar / Cotton Container
 DE-2662 80 x 80 mm
 DE-2663 100 x 60 mm
 DE-2664 100 x 80 mm
 DE-2665 100 x 100 mm
 DE-2666 120 x 80 mm
 DE-2667 120 x 100 mm
 DE-2668 150 x 100 mm
 DE-2669 150 x 150 mm
 DE-2670 180 x 150 mm
 DE-2671 180 x 180 mm
 DE-2672 200 x 200 mm
 DE-2673 240 x 240 mm



Sputum Cup
 DE-2674



Dressing Jar With Lid & Knob
 DE-2675 80 x 80 mm
 DE-2676 90 x 90 mm
 DE-2677 100 x 100 mm
 DE-2678 120 x 120 mm
 DE-2679 100 x 130 mm
 DE-2680 150 x 150 mm
 DE-2681 125 x 170 mm



Round Bowls
 DE-2682 80 x 35 mm
 DE-2683 125 x 60 mm



Spirit Lamp
DE-2684



Spirit Lamp
DE-2685



Spirit Lamp
DE-2686



Cotton Holding Jar
DE-2687



Cotton Holder
DE-2688



Cotton Holder
DE-2689



Cotton Wool Dispenser Acc.
to Methol
DE-2690



Needle Sterillization Tub
DE-2691



Round Endodontic Boxes
complete with lid
DE-2692 Ø mm. 94 - h. mm. 70



Endodontic Box
DE-2693

HOLLOWWARE INSTRUMENTS



DE-2694
100 x 180 x 11mm
Mini size



DE-2695
100 x 180 x 11mm
Mini size



DE-2696
100 x 180 x 11mm
Mini size



DE-2697
100 x 180 x 11mm
Mini size

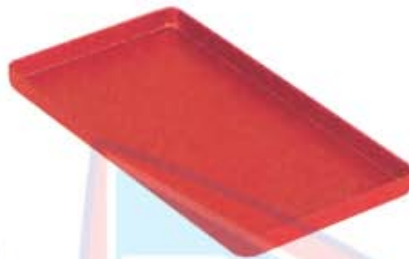

DE-2698
100 x 180 x 11mm
Mini size



Lid
Coperchio

DE-2699
103 x 182 x 10mm
Mini size



DE-2700
Silver

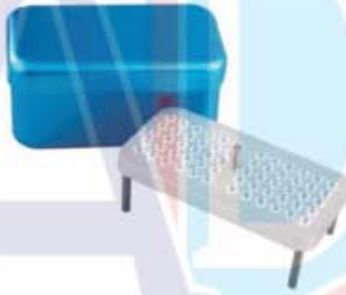

DE-2701 Blue
DE-2702 Red



DE-2703 Blue
DE-2704 Red



DE-2705
Silver



DE-2706
Green



DE-2708
Blue



DE-2707
Golden



DE-2709
Red



DE-2710
Silver



DE-2711
Midi
125 x 105 x 54mm



DE-2712
Maxi
204 x 105 x 54mm

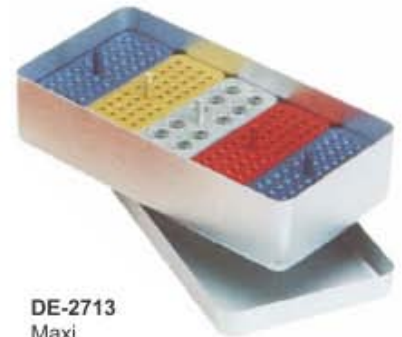

DE-2713
Maxi
204 x 105 x 54mm



Round Sterilizer Drum

- DE-2714 mm. Ø 80 x 80 H
- DE-2715 mm. Ø 125 x 80 H
- DE-2716 mm. Ø 125 x 100 H
- DE-2717 mm. Ø 125 x 125 H
- DE-2718 mm. Ø 150 x 80 H
- DE-2719 mm. Ø 150 x 100 H
- DE-2720 mm. Ø 150 x 130 H
- DE-2721 mm. Ø 150 x 150 H
- DE-2722 mm. Ø 150 x 190 H
- DE-2723 mm. Ø 190 x 125 H
- DE-2724 mm. Ø 190 x 145 H
- DE-2725 mm. Ø 190 x 165 H
- DE-2726 mm. Ø 190 x 190 H
- DE-2727 mm. Ø 190 x 240 H
- DE-2728 mm. Ø 190 x 290 H
- DE-2729 mm. Ø 240 x 120 H
- DE-2730 mm. Ø 240 x 145 H
- DE-2731 mm. Ø 240 x 165 H
- DE-2732 mm. Ø 240 x 190 H
- DE-2733 mm. Ø 240 x 240 H
- DE-2734 mm. Ø 240 x 290 H
- DE-2735 mm. Ø 240 x 340 H
- DE-2736 mm. Ø 240 x 390 H
- DE-2737 mm. Ø 290 x 145 H
- DE-2738 mm. Ø 290 x 165 H
- DE-2739 mm. Ø 290 x 190 H
- DE-2740 mm. Ø 290 x 240 H
- DE-2741 mm. Ø 290 x 290 H
- DE-2742 mm. Ø 290 x 340 H
- DE-2743 mm. Ø 290 x 390 H
- DE-2744 mm. Ø 340 x 145 H
- DE-2745 mm. Ø 340 x 165 H
- DE-2746 mm. Ø 340 x 190 H
- DE-2747 mm. Ø 340 x 240 H
- DE-2748 mm. Ø 340 x 290 H
- DE-2749 mm. Ø 340 x 340 H
- DE-2750 mm. Ø 340 x 390 H
- DE-2751 mm. Ø 390 x 140 H
- DE-2752 mm. Ø 390 x 165 H
- DE-2753 mm. Ø 390 x 190 H
- DE-2754 mm. Ø 390 x 240 H
- DE-2755 mm. Ø 390 x 290 H
- DE-2756 mm. Ø 390 x 340 H
- DE-2757 mm. Ø 390 x 390 H
- DE-2758 mm. Ø 390 x 490 H

Round Sterilizer Drums "Filter"

- DE-2759 mm. Ø 80 x 80 H
- DE-2760 mm. Ø 125 x 80 H
- DE-2761 mm. Ø 125 x 100 H
- DE-2762 mm. Ø 125 x 125 H
- DE-2763 mm. Ø 150 x 100 H
- DE-2764 mm. Ø 150 x 130 H
- DE-2765 mm. Ø 150 x 150 H
- DE-2766 mm. Ø 150 x 190 H
- DE-2767 mm. Ø 190 x 145 H
- DE-2768 mm. Ø 190 x 165 H
- DE-2769 mm. Ø 190 x 190 H
- DE-2770 mm. Ø 190 x 240 H
- DE-2771 mm. Ø 240 x 145 H
- DE-2772 mm. Ø 240 x 165 H
- DE-2773 mm. Ø 240 x 190 H
- DE-2774 mm. Ø 240 x 240 H
- DE-2775 mm. Ø 240 x 290 H
- DE-2776 mm. Ø 240 x 340 H
- DE-2777 mm. Ø 240 x 390 H
- DE-2778 mm. Ø 290 x 145 H
- DE-2779 mm. Ø 290 x 165 H
- DE-2780 mm. Ø 290 x 190 H
- DE-2781 mm. Ø 290 x 240 H
- DE-2782 mm. Ø 290 x 290 H
- DE-2783 mm. Ø 290 x 340 H
- DE-2784 mm. Ø 290 x 390 H
- DE-2785 mm. Ø 340 x 145 H
- DE-2786 mm. Ø 340 x 165 H
- DE-2787 mm. Ø 340 x 190 H
- DE-2788 mm. Ø 340 x 240 H
- DE-2789 mm. Ø 340 x 290 H
- DE-2790 mm. Ø 390 x 140 H
- DE-2791 mm. Ø 390 x 165 H
- DE-2792 mm. Ø 390 x 190 H
- DE-2793 mm. Ø 390 x 240 H
- DE-2794 mm. Ø 390 x 290 H
- DE-2795 mm. Ø 390 x 340 H
- DE-2796 mm. Ø 390 x 490 H

Round Bowls With Cover

- DE-2797 Ø 40 mm ml.30
- DE-2798 Ø 60 mm ml.50
- DE-2799 Ø 80 mm ml.150
- DE-2800 Ø 100 mm ml.250
- DE-2801 Ø 120 mm ml.450
- DE-2802 Ø 150 mm ml.750
- DE-2803 Ø 180 mm ml.1500
- DE-2804 Ø 200 mm ml.2100
- DE-2805 Ø 250 mm ml.3500

Round Bowls With Out Cover

- DE-2806 Ø 40 mm ml.30
- DE-2807 Ø 60 mm ml.50
- DE-2808 Ø 80 mm ml.150
- DE-2809 Ø 100 mm ml.250
- DE-2810 Ø 120 mm ml.450
- DE-2811 Ø 150 mm ml.750
- DE-2812 Ø 180 mm ml.1500
- DE-2813 Ø 200 mm ml.2100
- DE-2814 Ø 250 mm ml.3500

INSTRUMENTS MANAGEMENT SYSTEM

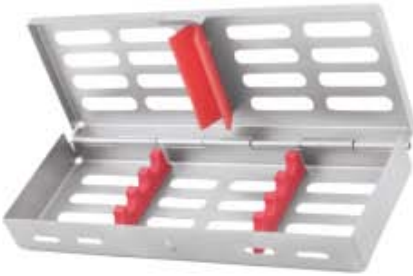

Cassette For 4 Instruments
DE-2815



Cassette For 5 Instruments
DE-2816



Cassette For 6 Instruments
DE-2817



Cassette For 7 Instruments
DE-2818



Cassette For 10 Instruments
DE-2819



Cassette For 20 Instruments
DE-2820



Cassette For Extraction Forceps
DE-2821



Cassette For Root Elevator
DE-2822



DE-2823
Cassette Tray
15 Pcs



DE-2824
Cassette Tray
15 Pcs



HOLLOWARE INSTRUMENTS

STERILIZING MESH TRAY

Different sizes & dimensions are available at buyer's demand



MESH TRAYS
DE-2825
Different sizes & dimensions are available at buyer's demand



MESH TRAYS
DE-2826
05 Pcs



MESH TRAYS
DE-2827
07 Pcs



MESH TRAYS
DE-2828
10 Pcs

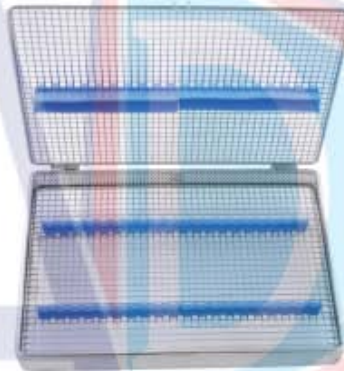

MESH TRAYS
DE-2829
20 Pcs



DE-2830
Mesh Cassettes
5 Pieces, 7 Pieces, 10 Pieces,
15 Pieces & 20 Pieces



MESH TRAY
DE-2831 240x130x50mm
DE-2832 240x130x60mm
DE-2833 240x250x50mm
DE-2834 240x250x60mm
DE-2835 480x250x50mm
DE-2836 480x250x60mm
DE-2837 480x250x70mm



MESH TRAY
DE-2838 240x250x 50mm
DE-2839 240x250x 60mm
DE-2840 240x250x 70mm
DE-2841 480x250x 50mm
DE-2842 480x250x 60mm
DE-2843 480x250x 70mm
DE-2844 480x250x100mm



MESH TRAY
DE-2845 240x250x50mm
DE-2846 240x250x60mm
DE-2847 240x250x70mm
DE-2848 280x250x50mm
DE-2849 280x250x60mm



MESH TRAY
DE-2850 280x250x 70mm
DE-2851 280x250x100mm
DE-2852 280x250x 50mm
DE-2853 280x280x 60mm
DE-2854 280x280x 70mm
DE-2855 300x280x 60mm

HOLLOWARE INSTRUMENTS



DE-2856
18×7×3.5cm
5 Instruments Cassette
Detachable Lids
+
5 Instruments Cassette Hinged
Lids with button Lock



DE-2857
29×18.5×3.5cm
20 Instruments Cassette Hinged
Lids with surgical kit fitting,
button lock



Instruments Cassette
DE-2858 5 Pieces Cassette
DE-2859 7 Pieces Cassette
DE-2860 10 Pieces Cassette



DE-2861
18×11×3.5cm
Extra large cassette for 6
Instruments, with compartment
for small parts hinged lids



DE-2862
29×18.5×3.5cm
20 Instruments Cassette
Detachable Lids
+
20 Instruments Cassette Hinged
Lids with button Lock

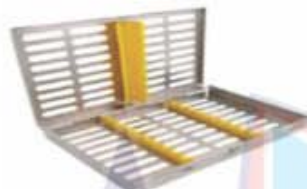

DE-2863
10×13×2.2cm
10 Instruments Cassette Hinged
Lids, Click Lock Available in 2
designs



DE-2864
29×18.5×3.5cm
20 Instruments Cassette Detachable
Lids with elevator fitting
+
20 Instruments Cassette Hinged
Lids with elevator fitting , button lock



DE-2865
18×9×2.2cm
7 Instruments Cassette Hinged
Lids, Click Lock, Available in 2
designs



DE-2866
21×14×3.5cm
15 Instruments cassette,
Detachable lids, button lock



DE-2867
21×14×3.5cm
15 Instruments cassette,
detachable lids, button
lock, with fitting of micro
surgery kit



DE-2868
21×14×4.5cm
8 pcs luxator/elevator
cassette, Detach0
ablelids, button lock



DE-2869
15×9×5cm
Box for dental implant tools and
surgical kits, Capacity:8
tools, 18 tools, 24 Tools, 58 Tools
+ removable compartment



Instruments Tray Perforated
DE-2870 288 x 187 x 40 mm



Instruments Tray Perforated Base
DE-2871 288 x 187 x 40 mm



Instruments Tray Solid Base
DE-2872 288 x 187 x 40 mm



DE-2873 Implant Basic Starter Kit 11 instruments with case



DE-2874 Crown Bridge Set Instruments with Case

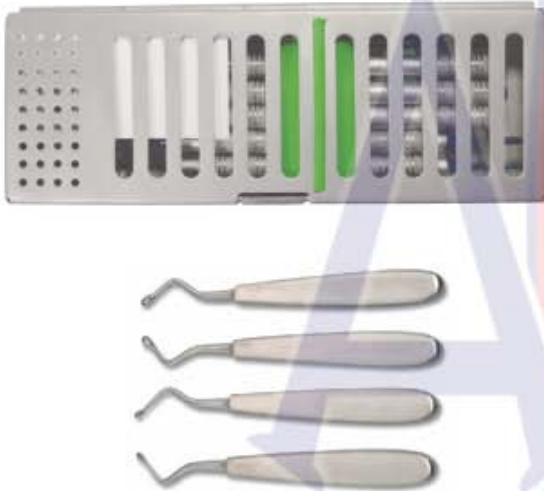

DE-2875 Bone Curettes Spoon Style set of 4 with Metal Case

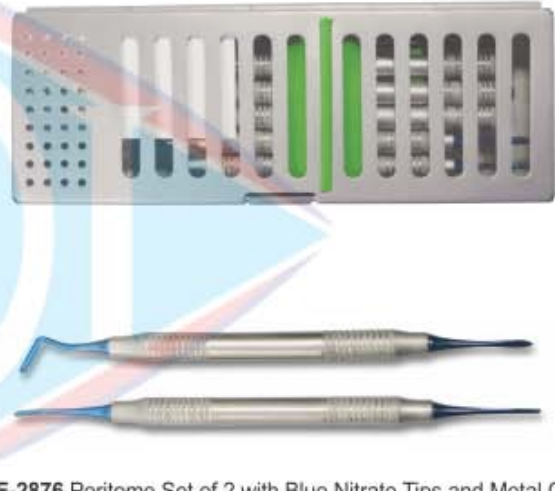

DE-2876 Peritome Set of 2 with Blue Nitrate Tips and Metal Case

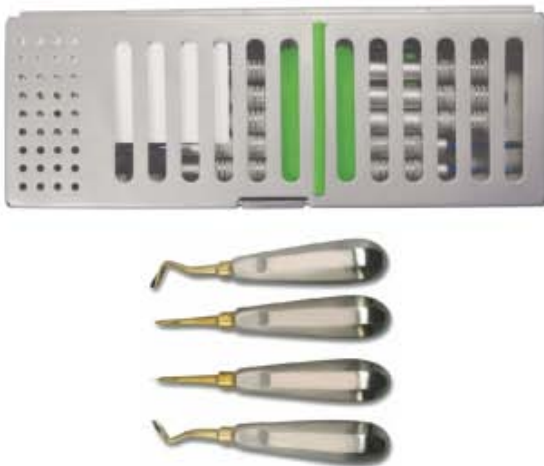

DE-2877 Root Fragment Removal elevators, Set of 4 with Metal Case



DE-2878 Peritome Set of 3 Gold Handles Serrated Blades with Metal Case



DESCRIPTION	PAGE#
A	
A COSMETIC CONTOURING IMPLANTOLOGY	148
AB1 BOGHOSIAN IMPLANTOLOGY	147
AB2 BOGHOSIAN IMPLANTOLOGY	147
ABOU-RASS EXPLORERS	54
ACUTE IMPLANTOLOGY	161
ADAMS PLIER	133
ADAMS PLIER ROUND BOX	138
ADAMS PLIERS FOR HOOKS AND BENDING	132
ADAMS, SMALL WIRE BENDING AND LOOP FORMING PLIERS	138
ADERER CLAMP THREE JAW WIRE BENDING PLIER	134
ADERER FACEBOW LOOP FORMING PLIERS	133
ADERER LARGE WIRE BENDING AND LOOP FORMING PLIERS	134
ADERER PLIER	36,141
ADHESIVE REMOVING PLIERS	169
ADSON 7X7 CURVED TISSUE FORCEPS	53
ADSON BROWN TWEEZERS	169
ADSON CARBIDE TIPPED TISSUE FORCEPS	107
ADSON NEEDLE HOLDERS	53
ADSON-TC TWEEZERS	88
ADULT PALATAL DENTAL PHOTOGRAPHIC MIRRORS	110
ALLIS HAEMOSTATIC FORCEPS	110
ALLIS-BABY HAEMOSTATIC FORCEPS	109
ALL PURPOSE PLIERS	127
ALUMINIUM CALIPER	102
ALM RETRACTOR	117
AMALGAM CARRIERS	116,117
AMALGAM INSTRUMENTS	115,117
AMALGAM WELL	54
ANATOMIC HANDLE EXPLORERS	87
ANDREWS FILLING INSTRUMENTS	139
ANGLE HOW PLIER	139
ANGLED DIRECT BOND BRACKET REMOVER TC	03
ANGLED EXTRACTING FORCEPS FOR UPPER ROOTS	136
ANGLED UTILITY PLIERS	111
ANISWORTH RUBBER DAM CLAMPS FORCEPS	58
ANTERIOR	06
APEX FORCEPS LOWER ROOT DEEP ROOT PICK	05
APEX FORCEPS LOWER UNIVERSAL DEEP ROOT PICK	29
APEXO ROOT ELEVATORS	23
APICAL RETENTION FORCEPS	31,33
APICAL ROOT ELEVATORS	30,143
ARCH BENDING PLIERS	139
ARROW CLASP FORMING PLIERS	87
ARTICULATORS	27
ASPIRATING SYRING	52
ATRAUMATIC TWEEZERS	52
ATRAUMATIC WITH LOCK TWEEZERS	
B	
BABY TOOTH EXTRACTION FORCEPS SET OF 7 PIECES	08
BACK ACTION FILLING INSTRUMENTS	88
BACKHAUS HAEMOSTATIC FORCEPS	110
BACKHAUS TOWEL CLAMPS	110
BACULITE HANDLE WAX KNIVES	96
BALL BURNISHERS	71
BALL FILLING INSTRUMENTS	83
BALL SOCKET NOT-PERFORATING AND NOT-DAMAGING	110
BALLACORN FILLING INSTRUMENTS	88
BAND REMOVING PLIERS	32,136
BAND SEATER AUTO CLEAVABLE	129
BAND SEATER AUTO CLEAVABLE ROUND SHAPE	129
BAND SEATER AUTO CLEAVABLE SQUARE SHAPE	129
BAND SEATER AUTO CLEAVABLE TRIANGLE SHAPE	129
BAND SEATING & REMOVING INSTRUMENTS	129
BAND SEATING & REMOVING SILICON GRIP	129
BAND SEATING PLIERS	141
BANDS & CROWNS PLIER	134
BARRAQUER T.C NEEDLE HOLDERS	109
BASINS FOR BONE	174
BAUMGARTNER NEEDLE HOLDERS	06,107
BAYONET ROOTS ELEVATOR SET	36
BEAVERTAIL FILLING INSTRUMENTS	88
BEEBEE GUM SCISSORS	106
BEERENDONK CALIPER	127
BEIN ROOT ELEVATORS	29,40
BENDING PLIER	138
BESEK COMPOSITE INSTRUMENTS	72
BESEK COMPOSITE MODELLING INSTRUMENTS	85
BESEK COMPOSITE PLUGGERS INSTRUMENTS	82
BESEK PLUGGERS	76
BEYER BONE ROUNDER	25
BIRANGLE SCALER	67
BIRD BEAK PLIER	38,141
BIRD BEAK PLIER FOR BENDING	138
BIRD BEAK PLIER STANDARD	133
BIRD BEAK WIRE BENDING & CUTTING PLIERS	134
BIRD BEAK WIRE BENDING PLIER	133
BISHOP RETRACTORS	101
BLACK FILLING INSTRUMENTS	80,87
BLACK SCALER	66
BLACK TITANIUM COLOUR COATED INSTRUMENTS	147,148,149
BLADE AND PUSHER	166
BLUE TITANIUM COATED BONE GRAFTING INSTRUMENTS	55,187
SET OF 7 PCS WITH CASSETTE	159
BLUMENTHAL BONE ROUNDER	25
BOLEY GAUGE	125
BONE BRACKET GAUGE	125
BONE CARRIER TITANIUM	165
BONE CRUSHER	174
BONE CRUSHER TITANIUM METAL CUTTER	174
BONE EXPANDER KIT	176
BONE EXPANDER SCREW & SURGICAL KITS	176
BONE FILES	119
BONE GRAFT	159
BONE GRAFT IMPLANTOLOGY	156
BONE GRAFT PACKER	164
BONE GRAFT/CARRIER TITANIUM	167
BONE GRAFTING INSTRUMENTS COMPACTOR /TAMPERS	166
BONE INJECTORS, COLLECTORS & SUCTION TUBE	175
BONE MILL	174
BONE ROUNDER	25
BONE SCRAPER	173
BONE SCRAPER STRAIGHT & CURVED	173
BONE SPOON PACKER	166

DESCRIPTION	PAGE#
BONE THICKNESS GAUGE	146
BONE UNIVERSAL KIT	176
BONE WELL	174
BOX FOR DENTAL IMPLANT TOOLS AND SURGICAL KITS	191
BOX JOINT PLIERS	132,133,134
BRACKET HOLDER TWEEZERS	128
BRACKET PLACER TWEEZERS	128
BRACKET PLACING TWEEZES	128
BRACKET REMOVING PLIER CURVED	132
BRACKET REMOVING PLIER ROUND BOX	132
BRACKET REMOVING PLIERS ANGLED	136
BRACKET REMOVING PLIERS STRAIGHT	136
BRACKET REMOVING PLIERS WITH PLASTIC TIP	136
BRACKET TWEEZERS SLOT ALIGNER	128
BREWER RUBBER DAM CLAMPS FORCEPS	111
BREUNING RETRACTORS	101
BUCCAL AND LINGUAL/PALATAL SCALER	61
BUCCAL DENTAL PHOTOGRAPHIC MIRRORS	86
BUCCAL SURFACES SCALER	61
BUCCAL-SMALL DENTAL PHOTOGRAPHIC MIRRORS	96
BURNISHER FILLING INSTRUMENTS	78,88
BURNISHERS	88
BURNISHERS CONSERVATIVE TREATMENT	149
BUSER PERIODONTAL INSTRUMENTS	121
C	
COSMETIC CONTOURING IMPLANTOLOGY	148
CARBIDE DIAMOND COATED POINT	24
CARRY FORCEPS	170
CARVER COMPOSITE MODELLING INSTRUMENTS	85
CARVERS INSTRUMENTS	89,90
CARVERS INSTRUMENTS CASSETTE FOR 5 INSTRUMENTS	90
CASSETTE FOR INSTRUMENTS	162
CASTROVIEJO CALIPERS	126
CASTROVIEJO GUM SCISSORS	105
CASTROVIEJO MICRO SCISSORS	108
CASTROVIEJO NEEDLE HOLDERS	107,109
CATHETERS TRAY WITH LID BOX WITH FILTER	104
CATRIDGE SYRING	27
CEMENT SPATULAS	95
CERI SAW	124
CHEEK RETAINER	101
CHILD PALATAL DENTAL PHOTOGRAPHIC MIRRORS	96
CHIP BURNER	116
CHISELS, SCRE FILES & SPOONE CURETTE	118
CHISELS SCALER	65,67
CHOMPRET ROOT ELEVATOR	42
CINCH BACK / TIE BACK DISTAL END BENDING PLIERS	137
CLAW/LIFT ROOTS ELEVATOR	37
COARSE SUCTION TUBES	178
COBRA IMPLANTOLOGY	196
COHEN UNIVERSAL EXTRACTING FORCEPS (AMERICAN PATTERN)	17
COLLEGE FORCEPS	51
COLLEGE TWEEZER	53
COLLEGE WITH LOCK TWEEZERS	52
COLLINS TONGUE FORCEPS	110
COLUMBIA RETRACTOR	99
COMBINATION RETRACTORS	101
COMWELLS FORCEPS ANATOMICAL HANDLE	36
COMPASSO DE WILLIS	127
COMPOSITE BALL PLUGGERS	76
COMPOSITE FILLING INSTRUMENTS	92,93
COMPOSITE FILLING INSTRUMENTS SET OF 6 PCS	93
COMPOSITE GOLD TIP INSTRUMENTS	93
COMPOSITE INSTRUMENTS	72,73
COMPOSITE INSTRUMENTS BLUE TITANIUM WITH CASSETTES	89
COMPOSITE INSTRUMENTS TITANIUM BLUE ENDODONTIC	89
COMPOSITE MODELLING INSTRUMENTS	85
COMPOSITE PLUGGERS INSTRUMENTS	82,83
COMPOSITE/PLASTIC FILLING INSTRUMENTS	87
CONDENSER IMPLANTOLOGY	150,161
CONE-SOCKET MOUTH MIRRORS	49
CONE-SOCKET FRONT SURFACE MOUTH MIRRORS	49
CONE-SOCKET MIRROR HANDLES FOR MOUTH MIRRORS	50
CONE-SOCKET PLAIN MOUTH MIRRORS	49
CONE-SOCKET RHODIUM MOUTH MIRRORS	49
CONE-SOCKET SOLID HANDLES FOR MOUTH MIRRORS	50
CONE-SOCKET SOLID OCTAGONAL HANDLES FOR MOUTH MIRRORS	50
CONTOURING PLIER	134,138
COPRACHO HOLLOWWARE INSTRUMENTS	107
CORROSION-RESISTANT	82
COTTON HOLDER	196
COTTON HOLDING JAR	196
COTTON WOOL DISPENSER ACC. TO METHOT	196
COUPLAND ROOT ELEVATORS	34
CRANE KAPLAN TWEEZERS	53
CRILE-WOOD NEEDLE HOLDERS	105,107
CROWN REMOVER	114
CROWN SPREADERS	114
CRUCIBLE TONGS	124
CRYER EXTRACTING FORCEPS (AMERICAN PATTERN)	12,13,18,20
CRYER ROOT ELEVATORS	32
CUTTER	139,142
CUTTER, UTILITY PLIERS & WIRE FORMING PLIERS	141
D	
DEAN GUM SCISSORS	105
DEBKEY ATRAUMATIC TISSUE FORCEPS	169
DELUX BOLEY GAUGE	127
DELUXE BRACKET HOLDER	128
DELUXE BRACKET HOLDER TWEEZERS	128
DENHARD RETRACTORS - MOUTH GAGS	100
DENTAL PHOTOGRAPHIC MIRRORS	98
DENTAL SYRINGES	27
DENTAURUM CALIPER	127
DERF NEEDLE HOLDERS	108,107
DETAILING STEP PLIER	139
DETAILING STEP PLIERS / BAYONET BENDING PLIERS	137
DIAMOND COATED MARGIN TRIMMERS	65
DIRECT BOND BRACKET HOLDER TWEEZERS	128
DIRECT BOND BRACKET HOLDER TWEEZERS, SMALL TIP	128
DIRECT BONDING BRACKET HOLDERS	128
DIRECT BRACKET REMOVER TC	140
DISC SYSTEM DENTAL SYRINGES	27
DISSECTING SET SET OF 11 PCS	94
DISSECTING SET SET OF 9 PCS	94



INDEX

DESCRIPTION PAGE#

DISTAL AMALGAM CARRIERS	117
DISTAL BENDER SILICON GRIP	129
DISTAL CUTTER	139
DISTAL END CUTTER	135
DISTAL END CUTTER FLUSH CUT	142
DISTAL END CUTTER, SAFETY HOLD PLIER (IDEAL FOR CUTTING WIRE) TC	140
DISTAL END, WIRE CUTTERS & BRACKET REMOVER PLIERS	140
DISTAL SCALER	67,63
DOUBLE ENDED CEMENT SPATULA	131
DOUBLE ROUNDED JAW BENDING PLIERS	138
DOUBLE ENDED EXPLORERS	54
DRESSING TWEEZERS	52,53
DYNAMOMETER	146

E	
EASY ACCESS TWEEZERS	128
EBNETER SCALER	64
ELASTIC INSTRUMENT SILICON GRIP	129
ELASTIC SEPARATING PLIER	140
ELASTIC SEPARATING PLIER ROUND HANDLE	140
ELASTOMERIC LIGATURE PLACING FORCEPS WITH GROOVE FALCON	140
ELEVATORS SET OF 8 PCS	46
ELEVATORS SET OF 8 PCS	46
ELLIOTT SIGVELAND RETAINERS	115
ENDO FINGER RULER SPAN MEASURE SCALE	125
ENDODONTIC BOX	186
ENDODONTIC EXPLORER	154
ENDODONTICS INSTRUMENTS	58
ERGO GRIP RETRACTOR	101
EURO BREECH LOADING DENTAL SYRINGES	27
EXAMINATORS EXPLORERS	51
EXCAVATOR INSTRUMENTS	74
EXCAVATORS	86
EXECT BRACKET HOLDER TWEEZERS	128
EXPLORERS	51,54,55,96
EXTRACTING FORCEPS (AMERICAN PATTERN)	120,24
EXTRACTING FORCEPS (ENGLISH PATTERN)	07to07,20

EXTRACTING FORCEPS (ENGLISH PATTERN) SET OF 10 PIECES	07
EXTRACTING FORCEPS	08
EXTRACTING FORCEPS AMERICAN ADULT SET OF 10 PCS	28
EXTRACTING FORCEPS AMERICAN ADULT SET OF 8 PCS	28
EXTRACTING FORCEPS CHILDREN PATTERN SET OF 10 PIECES	28
EXTRACTING FORCEPS ENGLISH ADULT SET OF 10 PCS	28
EXTRACTING FORCEPS PEDO SET OF 7 PCS	28
EXTRACTING FORCEPS SET	28
EXTRACTING FORCEPS SET OF 10 PIECES	28
EXTRACTING FORCEPS SET OF 10 PIECES	28
EXTRACTING FORCEPS SET OF 13 PIECES	28
EXTRA-FLEX IMPLANTOLOGY	147

F	
FALCON BEAK CONTOURING PLIERS	133,138
FARABEF RETRACTORS SET OF 2 PICES)	103
FELDMAN RETRACTOR	103
FILLING INSTRUMENTS (GOLD POINTED)	91
FILLING INSTRUMENTS	87,88,91,93
FILLING INSTRUMENTS CONSERVATIVE TREATMENT	69,70,75,78,79,81,84
FIRST AID EXAMINATION SET OF 3 PIECES	51
FLEXIBLE PERITOME	163
FLEXI-THIN IMPLANTOLOGY	147
FLORR ROOT ELEVATORS	29,33
FLUSH-CUT DISTAL AND CUTTING PLIERS	133
FLUSH-CUT DISTAL END CUTTER	135
FOERSTER DRESSING FORCEPS	110
FRAZIER SUCTION TUBES WITH FILTER	178
FREEDMAN "DUCKHEAD"	149
FREEDMAN BURNISHERS	149
FREEDMAN LARGE CONTACT FORMING	149
FREEDMAN SMALL CONTACT FORMING	149
FREER PERIODONTAL INSTRUMENTS	121
FREER PERIOSTEEL ELEVATORS	120
FRET SAW	124
FRIEDMAN BONE ROUNDER	25
FRIEDMANN ROOT ELEVATOR	36
FRIEDMANN-RICHARD PERIODONTAL INSTRUMENTS	122
FUZZI COMPOSITE MODELLING INSTRUMENTS	85

G	
GERALD TWEEZERS	52
GILLES TWEEZERS	62
GILLES NEEDLE HOLDER WITH SCISSORS	107
GLOVES BOX	184
GOLD COLOR SET DENTAL ORAL IMPLANTOLOGY SINUS SET OF 10 PCS WITH CASSETTE	156
GOLD MILL (LARGE)	174
GOLD MILL (SMALL)	174
GOLDMAN FOX SUPER CUT SCISSORS	108
GOLDMAN FOX EXPLORERS	55
GOLDMAN FOX SCISSORS	108
GOLDMAN-FOX GUM SCISSORS	104,105
GOLDMAN-FOX PERIODONTAL INSTRUMENTS	121
GOLDMANN-FOX SCALER	64
GRACEY AFTER FIVE	60
GRACEY CURETTES SCALER	61
GRACEY CURETTES	59,63
GRACEY MINI FIVE	60
GRACEY SCALER	61
GRAFT MATERIAL SPOON CONCAVE TIP FOR LARGER GRAFTS	165
GRAFT PACKER	166
GRAFT PACKER, CONCAVE	166
GRIPPER CARBIDE TIPPED TISSUE FORCEPS TC	109
GRITMAN CEMENT SPATULAS	95
GROSS MAIER DRESSING FORCEPS	110
GULDENER SCALER	64
GUM SCISSORS	104to108

H	
HAEMOSTATIC FORCEPS & TOWEL CLAMPS	110
HALSEY NEEDLE HOLDERS	106,107
HALSTEAD MOSQUITO HAEMOSTATIC FORCEPS	110
HALSTEAD MOSQUITO NEEDLE HOLDERS	107
HALTEPNZETTE WITH LOCK TWEEZERS	170

DESCRIPTION PAGE#

HAMMER HEAD DISTAL END BENDING PLIERS	137
HAMMER WITH WOODEN HANDLE	124
HANDLE ROUND HANDLES FOR MOUTH MIRRORS	50
HANDLES FOR MOUTH MIRRORS	50
HARD WIRE CUTTER	142
HARD WIRE CUTTER STRAIGHT	142
HARD WIRE CUTTER, 15° ANGLED	135
HARD WIRE CUTTER, 15° ANGLED NON-AUTOCALAWABLE	135
HARD WIRE CUTTER, STRAIGHT	140
HARD WIRE CUTTERS	140
HARRIS EXTRACTING FORCEPS (AMERICAN PATTERN)	13,18
HARTMANN (BABY MOSQUITO) NEEDLE HOLDERS	107
HEAT CARRIERS	57
HEBER BAYONET ROOTS ELEVATOR	40
HEBER ROOTS ELEVATOR	40
HEIDBRINK ROOT APPEX ELEVATOR	44
HEIDBRINK ROOT ELEVATORS	33,43
HEIDBRINK ROOTS ELEVATOR WARWICK-JAMES	44
HEIDEMANN FILLING INSTRUMENTS	93
HEIDEMANN SPATULAS	73
HEIGHT GAUGE 0.18 STAINLESS STEEL	125
HEIGHT GAUGE ALUMINIUM	125
HEMINGWAY TWEEZERS	53
HEX TORQUE WRENCH UNIVERSAL	177
HEXAGONAL HANDLES FOR MOUTH MIRRORS	50
HIRSCHFELD PERIODONTAL INSTRUMENTS	122
HIRT COMPOSITE MODELLING INSTRUMENTS	85
HIRT COMPOSITE PLUGGERS INSTRUMENTS	83
HIRT SCALER	66
HMG HEISTER	59
HOLLENBACK FILLING INSTRUMENTS	80,87
HOLLOW CHOP CONTOURING PLIERS	143
HOLLOW HANDLES FOR MOUTH MIRRORS	50
HOLLOW MIRROR HANDLES FOR MOUTH MIRRORS	50
HOLLOWWARE INSTRUMENTS	183,184,186,187,190,191
HOLZ SCALER	65
HOOK CRAMPING PLIER ANGLED STRAIGHT TC	140
HOOK KNIVES	96
HOPSON FILLING INSTRUMENTS	78
HOW PLIER	132
HOW PLIER CURVED	132
HOW PLIERS OFFSET	141
HOW PLIERS STRAIGHT	141
HOW STRAIGHT UTILITY PLIERS	136
HOWARD PERIOSTEEL ELEVATORS	130
HULL EXTRACTING FORCEPS (AMERICAN PATTERN)	19
HYLIN CEMENT SPATULAS	95
HYLIN ROOTS ELEVATOR	39

I	
IMPLANT GAGES	145
IMPLANT SINUS LIFT INSTRUMENTS	161,162
IMPLANTOLOGY	145to178
IMPLANTOLOGY 9 PCS OF SET	181
IMPLANTOLOGY SET OF 2 COMPOSITE BLUE TIP INSTRUMENTS	154
IMPLANTOLOGY SET OF 3 COMPOSITE BLUE TIP INSTRUMENTS	154
IMPLANTOLOGY SET OF 4 COMPOSITE BLUE TIP INSTRUMENTS	154
IMPLANTOLOGY SET OF 5 COMPOSITE GOLD TIP INSTRUMENTS	154
IMPRESSION TRAYS	179to182
IMPRESSION TRAYS PERFORATED FULL DENTURE SET OF 8 PCS	181
IMPRESSION TRAYS PERFORATED WITHOUT RIM LOCK	182
IMPRESSION TRAYS SOLID FULL DENTURE SET OF 08 PCS	181
IMPRESSION TRAYS SOLID FULL DENTURE SET OF 8 PCS	181
IMPRESSION TRAYS SOLID WITH RIM LOCK	182
IMPRESSION TRAYS SOLID WITH RIM LOCK SET OF 08 PCS	180
IMPRESSION TRAYS SOLID WITH RIM LOCK SET OF 08 PCS	180
IMPRESSION TRAYS SOLID WITH RIM LOCK SET OF 10 PCS	180
INSTRUMENTS BOX	184
INSTRUMENTS BOX PERFORATED	184
INSTRUMENTS BOX WITH HOOKS	184
INSTRUMENTS BOX WITH LID	184
INSTRUMENTS CASSETTE 10 HINGED	191
INSTRUMENTS CASSETTE 10 PIECES CASSETTE	191
INSTRUMENTS CASSETTE 15 SURGERY KIT	191
INSTRUMENTS CASSETTE	191
INSTRUMENTS CASSETTE 20 DETACHABLE	191
INSTRUMENTS CASSETTE 20 DETACHABLE LIDS	191
INSTRUMENTS CASSETTE 20 HINGED	191
INSTRUMENTS CASSETTE 5 DETACHABLE LIDS	191
INSTRUMENTS CASSETTE 5 HINGED LIDS WITH BUTTON LOCK	191
INSTRUMENTS CASSETTE 6 PIECES CASSETTE	191
INSTRUMENTS CASSETTE 7 HINGED	191
INSTRUMENTS CASSETTE 7 PIECES CASSETTE	191
INSTRUMENTS TRAY PERFORATED	183,191
INSTRUMENTS TRAY PERFORATED BASE	191
INSTRUMENTS TRAY SOLID BASE	191
INSTRUMENTS TRAYS	183
INSTRUMENTS TRAYS WITH COVER	184
INSTRUMENTS TRAYS WITH LID	183
INSTRUMENTS TRAYS WITHOUT COVER	184
INTRALIGAMENTAL ANESTHESIA SYRINGE	27
IRIS GUM SCISSORS	104
IRIS SUPER CUT SCISSORS	108
IRIS GUM SCISSORS	104,105,108
IVORY SIGVELAND RETAINERS	115
IVORY LIGHT WEIGHT RUBBER DAM CLAMPS FORCEPS	111
IVORY MATRIX RETAINERS	115
IVORY RETRACTORS	101
IVORY RUBBER DAM CLAMPS FORCEPS	111
IVANSON SPRING CALIPER FOR METAL AND PORCELAIN	126
IVANSON SPRING CALIPER FOR WAX	126

J	
JACQUETTE SCALER	63
JARABAK PLIERS	143
JECT ULTIMA DENTAL SYRINGES	27
JENNINGS RETRACTORS - MOUTH GAIGS	100
JOHNSON CONTOURING PLIERS	133
JOHNSON PLIERS FOR CROWN BAND CONTOURING	138
JONES TOWEL CLAMPS	110
JOSEPH GUM SCISSORS	105

K	
KALT NEEDLE HOLDERS TC	109
KELLS EXTRACTING FORCEPS (AMERICAN PATTERN)	15



DESCRIPTION	PAGE#
KELLY GUM SCISSORS	104,105
KELLY HAEMOSTATIC FORCEPS	110
KELLY-RANKIN HAEMOSTATIC FORCEPS	110
KEY RINGS	94
KEYS FOR IMPLANT SCREW	177
KILNER (RAGNELL) GUM SCISSORS	105
KIRKLAND SCALER	54
KLEIN EXTRACTING FORCEPS	58
KLEINERT-KUTZ BONE ROUNDER	25
KOPP ROOTS ELEVATOR	39
KRAMER NEVINS SINUS LIFT	162
KRAMER-NVINS PERIODONTAL INSTRUMENTS	121
KRARNER-NEVINS BONE CHISEL	119
KUEHNE TWEEZERS	170
L	
LA GRANGE NEEDLE HOLDERS	109
LA GRANGE GUM SCISSORS	104,105
LADMORE FILLING INSTRUMENTS	88
LADMORE IMPLANTOLOGY	149
LAGRANGE SCISSORS	108
LAGRANGE SUPER CUT SCISSORS	108
LANGENBECK RETRACTORS	103
LANGER SCALER	63
LAP & L-KEY JOINT PLIERS	139
LARGE FLUOR-CUT DISTAL AND CUTTING PLIERS	133
LAXTOR ROOT ELEVATORS	30,31
LAXTOR ROOT ELEVATORS SET OF 9 PCS	36
LE CRON CEMENT SPATULAS	95
LECLUSE BAYONET ROOT ELEVATOR	41
LESSMANN WAX KNIVES	96
LICHTENBERG-RYDER T.C NEEDLE HOLDERS	109
LIGATURE FORMING PLIERS	134
LIGATURE INSTRUMENT SILICON GRIP	129
LIGHT WORE BIRD BEAK PLIERS WITH GROOVE	143
LINDO-LEVIAN ROOT ELEVATORS	35
LINGUAL / PALATAL ARCH FORMING PLIERS	134
LINGUAL ARCH FORMING PLIERS	143
LINGUAL DENTAL PHOTOGRAPHIC MIRRORS	88
LINGUAL-PALATAL SURFACES SCALER	81
LINGUAL-LARGE DENTAL PHOTOGRAPHIC MIRRORS	98
LIP & CHEEK RETRACTOR	100
L-KEY JOINT PLIERS	139a,136
LOCKLIN GUM SCISSORS	105
LONDON COLLEGE TWEEZERS	52
LONDON HOSPITAL	34
LONG IMPLANT DRILLS	178
LOOP FORMING IN FOUR LENGTH	138
LORNHAEMOSTATIC FORCEPS	110
LUCAS IMPLANTOLOGY	168
LUER BONE ROUNDER	25
LUXS	58
LUXATING ELEVATOR / PERIOTOME	36
LUXATING ELEVATOR WITH PERIOTOME TIP	36
LUXATOR ROOT ELEVATORS	29
LUXATOR/ELEVATOR 5 PCS	191
LUXATORS SET OF 7 PCS	46
LUXATORS SET OF 8 PCS	46
LUXATOR ROOTS ELEVATOR	40
LUXATORS CURVED ATRAMAATIC LUXATION OF THE TOOTH	48
LUXATORS STRAIGHT ATRAMAATIC LUXATION OF THE TOOTH	48
M	
MAGNIFYING MOUTH MIRRORS	49
MALLET IMPLANTOLOGY	174
MALLETS - PLASTER SHEARS - SAWS & BLADES	124
MANUAL ASPIRATING SYRINGE	27
MANUAL CROWN REMOVERS	114
MARGIN TRIMMERS	66
MARGINAL RIDGE & EMBRASURE SHAPING INSTRUMENT	148
MARKLEY FILLING INSTRUMENTS	93
MARQUETTE CONDENSER	87
MARQUETTE PLUGGERS	87
MARYAM TWEEZERS	53
MATHEU NEEDLE HOLDERS	107
MATRIX RETAINERS	115
MAXI HULL-DWARRE INSTRUMENTS	187
MAYO GUM SCISSORS	108
MAYO NEEDLE HOLDERS	183
MAYO TRAY PERFORATED	183
MAYO-HEGAR NEEDLE HOLDERS	106,107
MCCALL SCALER	63
MEAD BONE ROUNDER	25
MEAD NON AUTO CLAWABLE PLASTIC TIPS	119
MEASURING LOOP	128
MEASURING LOOP, CASTROVEJO	128
MEASURING PROBE	145
MEISSNER EXTRACTING FORCEPS	26
MEMBRANE IMPLANTOLOGY	161
MEMBRANE 3POSITIONING IMPLANTOLOGY	150
MEMBRANE DETACH ELEVATOR	164
MEMBRANE ELEVATOR	164
MEMBRANE TWEEZERS	170
MERRIAM TWEEZERS	52
MERRIT 6 EXPLORERS	55
MERSON BAND PUSHER	129
MESH CASSETTES 9 PIECES, 7 PIECES, 10 PIECES, 15PIECES & 20 PIECES	190
MESH TRAY	190
MESH TRAYS 05 PCS	190
MESH TRAYS 07 PCS	190
MESH TRAYS 10 PCS	190
MESH TRAYS	190
MESH TRAYS 20 PCS	190
MESIAL SCALER	81
METZENBAUM GUM SCISSORS	104,108
MICRO ADSON 1X2 TISSUE FORCEPS	169
MICRO BOLEY GAUGE STRAIGHT	146
MICRO BOLEY GAUGE TWISTED	146
MICRO IRIS GUM SCISSORS	104
MICRO SURGICAL SCALPEL HANDLE TITANIUM	123
MICRO-FRIEDMAN BONE ROUNDER	25
MICRO-MINI PIN & LIGATURE CUTTER	142
MIDDELBOFF RETRACTORS	103
MILLER BONE FILES	119
MILLER ROOT ELEVATORS	37

DESCRIPTION	PAGE#
MILLER IMPLANTOLOGY	168
MILLER ROOT PLANNING FILES	119
MILLER TWEEZERS	53
MINI DISTAL AMALGAM CARRIERS	117
MINI GAUGE	127
MINI LIGATURE CUTTERS	133
MINI PIN & LIGATURE CUTTER	142
MINI PIN & LIGATURE CUTTER TC	139
MINI-LANGENBECK RETRACTORS	102
MINI-SPATEL BURNISHERS	71
MINNESOTA RETRACTORS	101
MIRROR EXPLORERS	51
MIRROR HANDLE STEM WITH RULE HANDLES FOR MOUTH MIRRORS	50
MISCELLANEOUS PRODUCTS	94
MIXING SPATULA WITH SHOVEL	165
MOLT 9 PERIODONTAL INSTRUMENTS	121
MOLT AUTO CLAWABLE PLASTIC TIPS	119
MONARI COMPOSITE MODELLING INSTRUMENTS	85
MORTENSON FILLING INSTRUMENTS	80,87
MOUTH MIRROR EXPLORERS	51
MOUTH MIRRORS	49
MOUTH PROPS	94
MOVEABLE HEIGHT GAUGE	125
MSY CEMENT SPATULAS	95
MUEHLMANN SCALER	64,65
MULTIFUNCTIONAL METER	145
MULTI-PURPOSE PLIERS	137
N	
NAKAWALNI DENTAL LABORATORY INSTRUMENT	97
NANCE LOOP FORMING PLIERS	132,137
NAPKIN HOLDER WITH METAL CHAIN	94
NAPKIN HOLDER WITH PLASTIC CHAIN	94
NARROW SIQVELAND RETAINERS	115
NEEDLE HOLDERS	106a,109
NEEDLE STERILIZATION TUB	186
NEUMANN GUM SCISSORS	105
NEVINS EXTRACTING FORCEPS (AMERICAN PATTERN)	14,16
NORMAL HANDLE EXPLORERS	54
NOYES GUM SCISSORS	105
O	
OBTUSE IMPLANTOLOGY	161
OCCUSAL ANATOMY INSTRUMENT	148
OH - PERIOSTEEL ELEVATORS	107
OLSEN-HEGAR NEEDLE HOLDER WITH SCISSORS	161
OMEGA LOOP FORMING PLIERS	161
ORBAN SCALER	64
ORTHO BAND PUSHER SCALER	131
ORTHO INSTRUMENT	130
ORTHO LIGATURE DIRECTOR SINGLE ENDED	131
ORTHO LIGHT BAND PUSHER SCALER	129
ORTHO LIGHT DOUBLE ENDED LIGATURE	131
ORTHO LIGHT DOUBLE ENDED LIGATURE DIRECTOR	131
ORTHO LIGHT DOUBLE ENDED LIGATURE DIRECTOR SCALER	129,131
ORTHO LIGHT DOUBLE ENDED LIGATURE SCALER	131
ORTHO LIGHT LIGATURE DIRECTOR DOUBLE ENDED	131
ORTHO LIGHT SCALER	130
ORTHO LIGHT SCALER DOUBLE ENDED	130
ORTHO LIGHT SCALER HEAVY	130
ORTHO LIGHT SCALER SINGLE ENDED	131
ORTHO RULER / CONE SOCKET	146
ORTHODONTIC INSTRUMENTS	175a,131
ORTHODONTICS PLIERS STANDS	144
ORTHOLITE LIGATURE DIRECTOR SCALER	131
OSTEOMETER MEASURING FORCEPS FOR JAW	146
OSTEOTOME CONVEXES / CONCAVE / CONIQUES	171,172
OSTEOTOME CONVEXES / CONCAVE / CONIQUES SET OF 5 PIECES	172
P	
PK. THOMS WAXING INSTRUMENTS KIT	89
P.K. THOMS WAXING INSTRUMENTS SOLID HANDLE	89
PALATAL-ADULT DENTAL PHOTOGRAPHIC MIRRORS	98
PALATAL-ADULT LARGE DENTAL PHOTOGRAPHIC MIRRORS	98
PALATAL-CHILD DENTAL PHOTOGRAPHIC MIRRORS	96
PALMER RUBBER DAM CLAMPS FORCEPS	111
PAMILY EXTRACTING FORCEPS (AMERICAN PATTERN)	16
PARTSCH PERIOSTEEL ELEVATORS	120
POL ELEVATORS	47,48
POL ELEVATORS SET OF 7 PCS	47
POL ELEVATORS SET OF 7 PCS	47
POL ELEVATORS SET OF 8 PCS	48
PEDIATRIC TOOTH EXTRACTING FORCEPS SET	58
PEET SPLINTER FORCEPS	109
PERFORATED WITH RIM LOCK SET OF 06 PCS	179
PERFORATED WITH RIM LOCK SET OF 10 PCS	179
PERFORATED WITH RIM LOCK SET OF 8 PCS	179
PERIODONTAL CHISELS	118
PERIODONTAL INSTRUMENTS	120a,122
PERIODONTAL KNIVES	64
PERIODONTAL PROBES	58
PERIODONTAL PROBESSPREADERS	57
PERIODONTAL SURGERY	162
PERIOSTEEL	
ELEVATORS	120,154
PERIOTOME ROOTS ELEVATOR	43
PERRY TWEEZERS	52,53
PHYSIC EXTRACTING FORCEPS (AMERICAN PATTERN)	18
PIN & LIGATURE CUTTERS	142
PIN & LIGATURE CUTTERS TC	135
PIN HOLDING PLIER TC	140
PIN-TWEEZERS	170
PLAIN MOUTH MIRRORS	49
PLANATOR	69
PLANATOR	69
PLASTER KNIFE	96
PLASTER SHEARS	124
PLASTIC FILLING INSTRUMENTS	93
PLIER STAND PLASTIC	144
PLIER STAND STAINLESS STEEL	144
PLIERS FOR ORTHODONTICS & PROSTHETICS	132a,143
PLIERS STAND STAINLESS ROD (ALUMINUM ANCOIZED)	144
PLUGGERS	56
PLUGGERS/CONDENSERS	87
POSITIONING 3 IMPLANTOLOGY	161



INDEX

DESCRIPTION	PAGE#
POSITIVE POSITIONER	125
POSTERIOR BAND REMOVING PLIERS - LONG	141
POSTERIOR BAND REMOVING PLIERS - SHORT	141
POITTS "T-HANDLE" ELEVATOR-LEFT	41
POITTS "T-HANDLE" ELEVATOR-RIGHT	41
PRICHARD PERIODONTAL INSTRUMENTS	121
PROBE EXPLORERS	51
PRONG 3 CLASP ADJUSTABLE PLIER TC	140
Q	
QUATRO DENTAL SYRINGES	27
R	
RASPATOR, PRICHARD	165
RASPATOR, RASPATORY	120
RASPATOR, WILLIGER	120
RECTANGULAR ARCH BENDING PLIERS	143
RETRACTOR SELDIN	103
RETRACTORS - MOUTH GAGS	99,100
RETRACTORS	101to103
RHOCULUM MOUTH MIRRORS	49
RIBBON RETRACTORS	101
RIDGE MAPPING DOUBLE CALIPER	146
RING 2 DENTAL SYRINGES	27
ROCHESTER-KOCHER HAEMOSTATIC FORCEPS	110
ROCHESTER-PEAN HAEMOSTATIC FORCEPS	110
ROOT CANAL PLUGGER	56
ROOT ELEVATOR	29to48
ROOT ELEVATORS SET OF 10 PCS	46
ROOT FRAGMENT FORCEPS	99,111
ROOT PICK ELEVATOR WITH GOLD FLEXIBLE POINTS	42
ROOT PLANNING FILES	119
ROOT PLANNING FILES & BCME FILES	119
ROOTS SPLINTER FORCEPS	10
ROSER-KÖNIG RETRACTORS - MOUTH GAGS	100
ROUND AND CONCAVE PLIER	139
ROUND ENDODONTIC BOXES	186
ROUND EXCAVATOR	86
ROUND TORQUE WRENCH UNIVERSAL	177
ROUTURIER EXTRACTING FORCEPS (ENGLISH PATTERN)	03
ROUTURIER EXTRACTING FORCEPS FOR LOWER MOLARS	03
RUBBER DAM CLAMPS	113
RUBBER DAM CLAMPS FORCEPS	111
RUBBER DAM CLAMPS KITS	113
RUBBER DAM FRAME	111
RUBBER DUM TEMPLATE	112
RULER	127
RULER WEDGE	127
RUSSIAN LONG TISSUE FORCEPS	170
RUSSIAN TISSUE FORCEPS	170
RYDER NEEDLE HOLDERS	106,107
S	
SAW BLADES	124
SCALER	59to67
SCALERS TRAYS	183
SCALPEL HANDLE STRAIGHT	123
SCALPEL HANDLES	123
SCHLEMMER ROOTS ELEVATOR	37
SCHWOLIN PERIODONTAL INSTRUMENTS	122
SCHURE BAND SEATER	130
SCHWARZ PLIERS	139
SEPARATING ELASTIC PLIER	111
SELDEN PERIODONTAL INSTRUMENTS	122
SELDIN ROOT ELEVATORS	29,32
SELF LOCKING GROOVED	169
SELF-LOCKING TWEEZER	53
SEMKEN TAYLOR TWEEZERS	52
SENN MUELLER RETRACTOR	102
SERRATED PLUGGERS	84
SET OF 6 PIECES	171
SHEPHERD'S HOOK EXPLORER	54
SHORT IMPLANT DRILLS	176
SICKLE SCALERS	63
SIWPLEX RETRACTOR	100
SINUS ELEVATOR & MEMBRANE LIFT TIPS	164
SINUS IMPLANTOLOGY	156,161
SINUS LEFT ELEVATOR & MEMBRANE LIFT TIPS 3 SET OF 7 PCS	164
SINUS LEFT ELEVATOR SET OF 10 PCS	158
SINUS LIFT ELEVATOR	151,157
SINUS LIFT ELEVATORS SET OF 7 PCS WITH CASSETTE	151
SINUS LIFT INSTRUMENT	150to152,161
SINUSLIFT IMPLANTOLOGY	150,161
SIOVELAND RETAINERS	115
SLIM WEINGART PLIERS	141
SLIPPER TWEEZERS	128
SMAHA ELASTOMERIC LIGATURE PLACING FORCEPS	140
SMALL/MEDIUM BALL BURNISHER	149
SOFT BRUSHING KIT SET OF 6 PCS	163
SOFT WIRE AND LIGATURE CUTTER	135
SOFT WIRE AND LIGATURE CUTTER, STANDARD	135
SPATULAS	73
SPATULAS ROUNDED AND SHARP	72
SPECIAL INOX	124
SPECIAL INOX WAX KNIVES	96
SPENCER GUM SCISSORS	105
SPRIT LAMP	186
SPLINTER FORCEPS	10
SPOON AND PUSHER (TRINOVO)	167
STANDARD LIGATURE CUTTER TC	139
STAR TORQUE WRENCH UNIVERSAL	177
STERILIZING BOXES & INSTRUMENTS TRAYS	184
STERILIZING MESH TRAY	190
STERNBERG RETRACTORS	99
STIEGLITZ ROOT FRAGMENTS	10
STIEGLITZ SPLINTER FORCEPS	10
STOCKES RUBBER DAM CLAMPS FORCEPS	111
STOP PLIERS V-DESO	137
STRAIGHT DIRECT BOND BRACKET REMOVER TC	140
STRIP SAW	125
SUCTION CANNULA KIT WITH 3 NEEDLES	178
SUCTION NEEDLE	178
SUCTION PIPE	178
SUCTION TUBES	178
SURGICAL TWEEZERS	52

DESCRIPTION	PAGE#
SURGICAL BALL HOOK CRIMPING PLIERS, ANGLED	137
SURGICAL BALL HOOK CRIMPING PLIERS, STRAIGHT	137
SURGICAL CHISELS	162
SUTURE PLIERS SUTURE FORCEPS	169
SWEDISH TYPE DENTAL SYRINGES	27
SYNDEMOTOMES ROOTS ELEVATOR	43
T	
TAMPER	166
TANNER FILLING INSTRUMENTS	68
TARTAR REMOVER INSTRUMENTS SOLID HANDLE	67
TAYLOR SCALER	63
THICK EXPLORERS	54
THREE JAW PLIERS	143
TISSUE GRAFT FORCEP SERRATED TEETH	169
TISSUE MEMBRANE FORCEPS	169,170
TISSUE PUNCH	173
TISSUE PUNCH FORCEPS TO REMOVE TISSUE AFTER USING PUNCH	170
TISSUE PUNCH SET OF FIVE PIECES	173
TISSUE PUNCH STRAIGHT & CURVED	173
TISSUE PUNCH WITH PIN SET OF FOUR PIECES	173
TITANIUM LOCKING PLIER	169
TITANIUM PERIOSTEAL ELEVATOR FOR IMPLAN	122
TOFFLEMIRE-JUNIER SIOVELAND RETAINERS	115
TOFFLEMIRE-SENIOR SIOVELAND RETAINERS	115
TOMAS EXTRACTING FORCEPS (AMERICAN PATTERN)	17,22
TOMAS NEEDLE HOLDERS	102
TORQUE WRENCH & RATCHET	177
TORQUING PLIERS SET	137
TOWNER-JAQUETTE SCALER	63
TREPINE	175
TREPINE DRILL SET OF EIGHT PIECES	175
TRINOVO HANDLE	167
TRIO DENTAL SYRINGES	27
TRIPLE-ANGLED BACK ACTION EXCAVATOR	86
TWEED / ANGEL FORMING AND TORQUING PLIERS	134
TWEED / ANGEL RECTANGULAR ARCH FORMING AND TORQUING PLIERS	137
TWEED / ANGLE RECTANGULAR ARCH FORMING & TORQUING PLIERS	133
TWEED LOOP FORMING PLIERS	132,133,143
TWEEZERS	52,53
TWEEZERS EXPLORERS	51
TWEL-ON ELASTIC MODULE INSTRUMENT	130
TYPE C DENTAL SYRINGES	27
U	
UNIQUE RETRACTORS	102
UNIVERSAL CROWN REMOVER	114
UNIVERSAL CURETTES	63
UNIVERSAL CUT & HOLD DISTAL END CUTTER	142
UNIVERSAL DOLPHIN STYLE WIRE BENDING & CUTTING PLIERS	132
UNIVERSAL EXTRACTING FORCEPS (AMERICAN PATTERN)	22
UNIVERSAL MINI-ELEVATOR FOR FRAGMENTS	34
UNIVERSAL NEEDLE HOLDERS	106
UNIVERSITY OF MICHIGAN EXPLORERS	55
UNIVERSITY OF NORTH CAROLINA EXPLORER	55
UPPER ROOT ELEVATOR WITH HELICOIDAL TIP	31
US ARMY RETRACTORS	102
UTILITY PLIER WEINGART TC	140
V	
V BEND STOP	139
V BEND STOP PLIER TC	139
VERNIER GAUGE	127
VISTA TUNNELING INSTRUMENTS SET	155
W	
W BARRY ROOTS ELEVATOR	41
WAHL BONE FILES	119
WAKAI HEAT CARRIERS	57
WALDSAWHS WIRE BENDING AND CUTTING PLIERS	134
WANGEN HOLDER	99
WARD FILLING INSTRUMENTS	80
WATER SYRINGE	116
WAX KNIVES	96
WAY 6 ADJUSTABLE ANGLED SCALPEL HANDLE	123
WEIDER RETRACTOR	99
WEINGART PLIER	139
WEINGART PLIER MEDIUM	132,134
WEINGART PLIERS	141
WEINGART UTILITY PLIERS	136
WEINGART MINI UTILITY PLIERS	136
WEITLANER RETRACTORS - MOUTH GAGS	100
WERDELSTAEDT SCALER	67
WESTCOTT BURNISHERS	68
WESTCOTT FILLING INSTRUMENTS	63
WESTON CEMENT SPATULAS	95
WHITE BURNISHERS	68
WIDE SIOVELAND RETAINERS	115
WILAND SCALER	65
WILKINS/TUFTS EXPLORER	54
WILLIAMS EXPLORERS	55
WILLIAMS FILLING INSTRUMENTS	81
WINTER EXTRACTING FORCEPS (AMERICAN PATTERN)	12
WINTER ROOTS ELEVATOR	41
WIRE BENDING & LOOP FORMING PLIERS	132
WIRE BENDING AND LOOP FORMING PLIERS ANGLED (BIRD BEAK)	136
WISDOM EXTRACTING FORCEPS	03
WISDOM ROOT ELEVATOR	36
WITZEL FORCEPS WITH ANATOMICAL HANDLE SET OF 3 PCS	09
WITZEL FORCEPS WITH GOLD SET OF 3 PCS	09
WITZEL FORCEPS WITH HOLE AND SCREW PATTERN SET OF 3 PCS	09
WITZEL ROOT FRAGMENT FORCEPS	09
WOODEN HANDLE WAX KNIVES	96
X	
X RAY FILM HANGERS	94
Y	
YOUNG TONGUE FORCEPS	110
YOUNG WIRE BENDING & LOOP FORMING PLIERS	132
YOUNGER GOOD SCALER	63
Z	
ZAHLE CEMENT SPATULAS	95



ATTA DENTAL INSTRUMENTS

Manufacturers & Exporters Medical, Dental & Manicure Instruments.

New Miana Pura Near Lunda Phatak Sialkot Pakistan
Cell/WhatsApp: +92-300-0264399 +92-341-1880277
Cell:+92-300-7169630 +92-336-6114489 +92-302-8744381
Email: info@attadental.com
Web: www.attadental.com

